

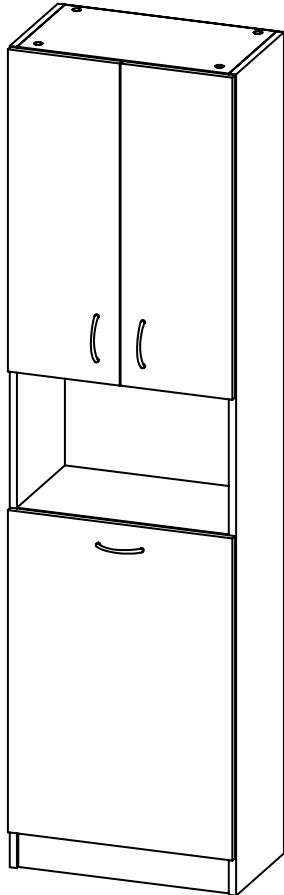

















ASSEMBLY INSTRUCTION









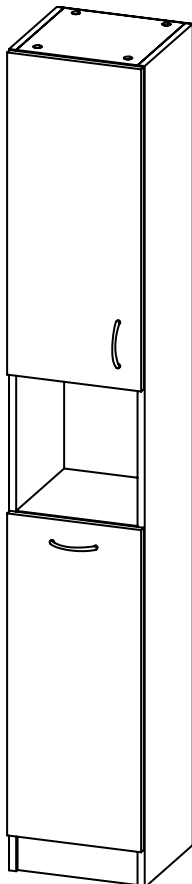









SIME510

A  x16	B  x16	C  x20	D  x4	E  x4	F  x4	G  x12	H  x22	I  x4
J  x8	K  x2	L  x4	M  x30	N  x4	O  x2	P  x2	R  x1	

ASSEMBLY INSTRUCTION



SIME310

A  x16	B  x16	C  x20	D  x4	E  x2	F  x2	G  x12	H  x18	I  x2
J  x4	K  x2	L  x4	M  x30	N  x4	O  x2	P  x2	R  x1	

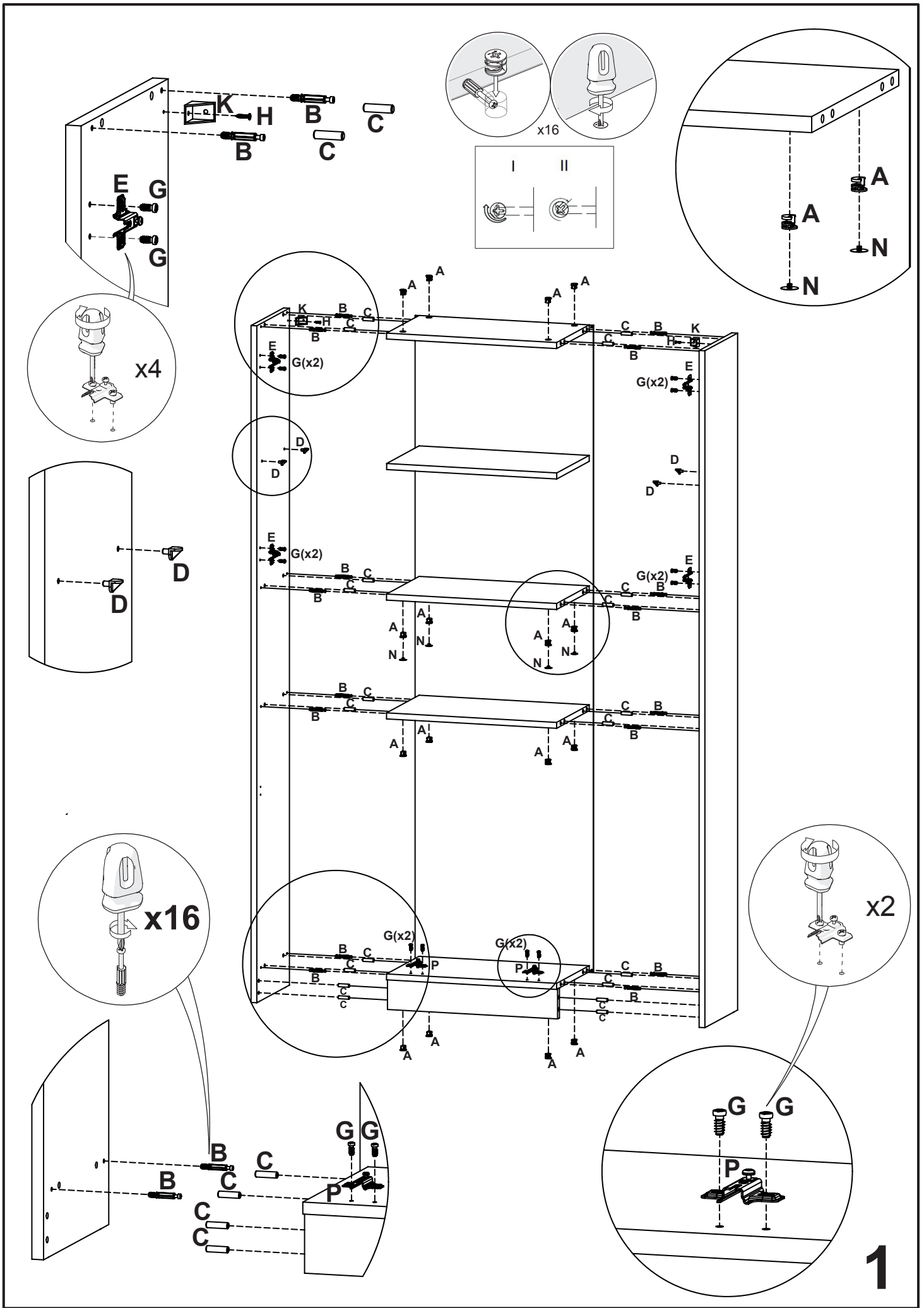

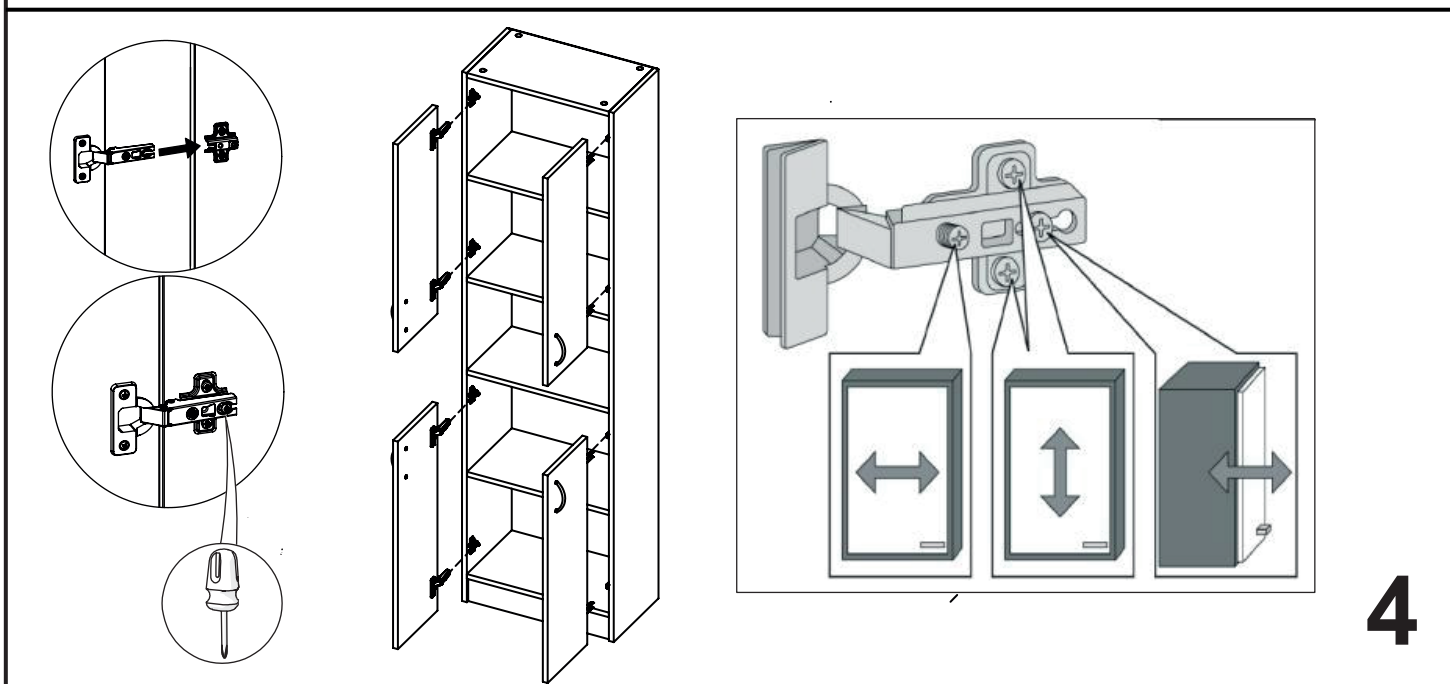
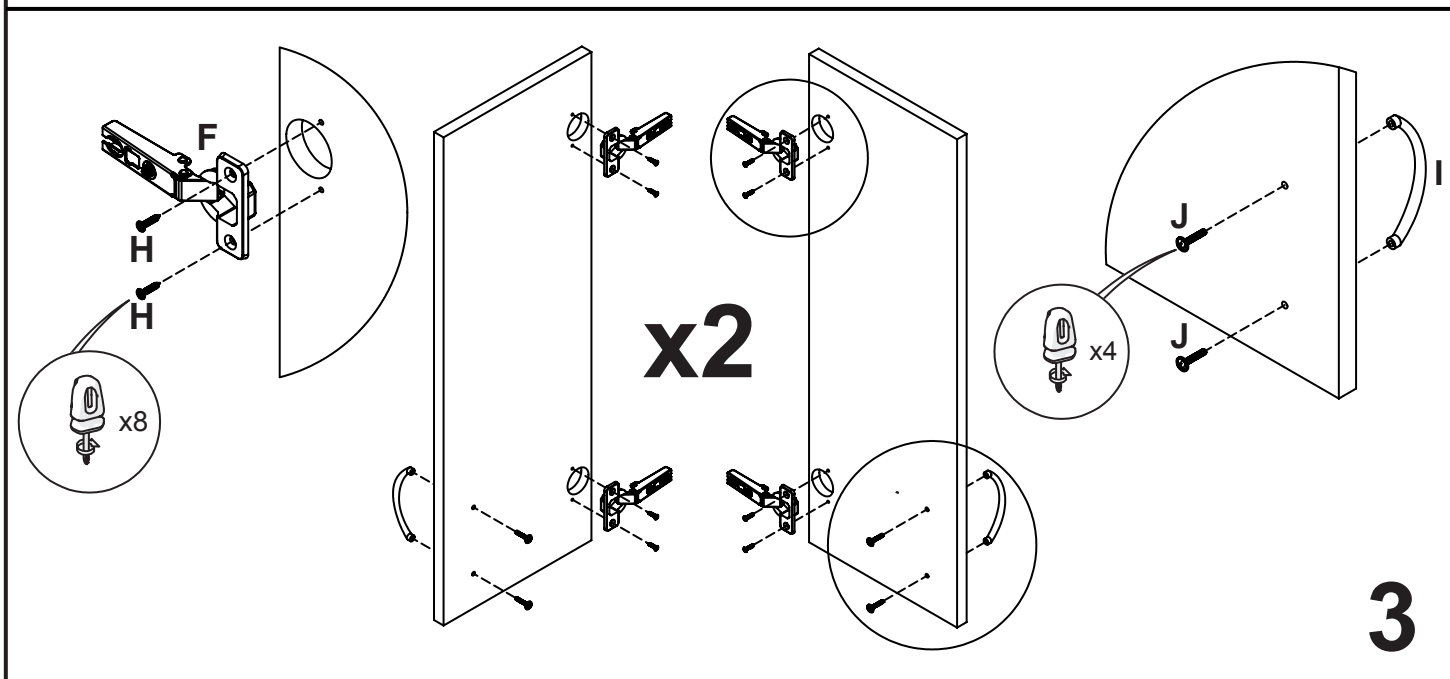
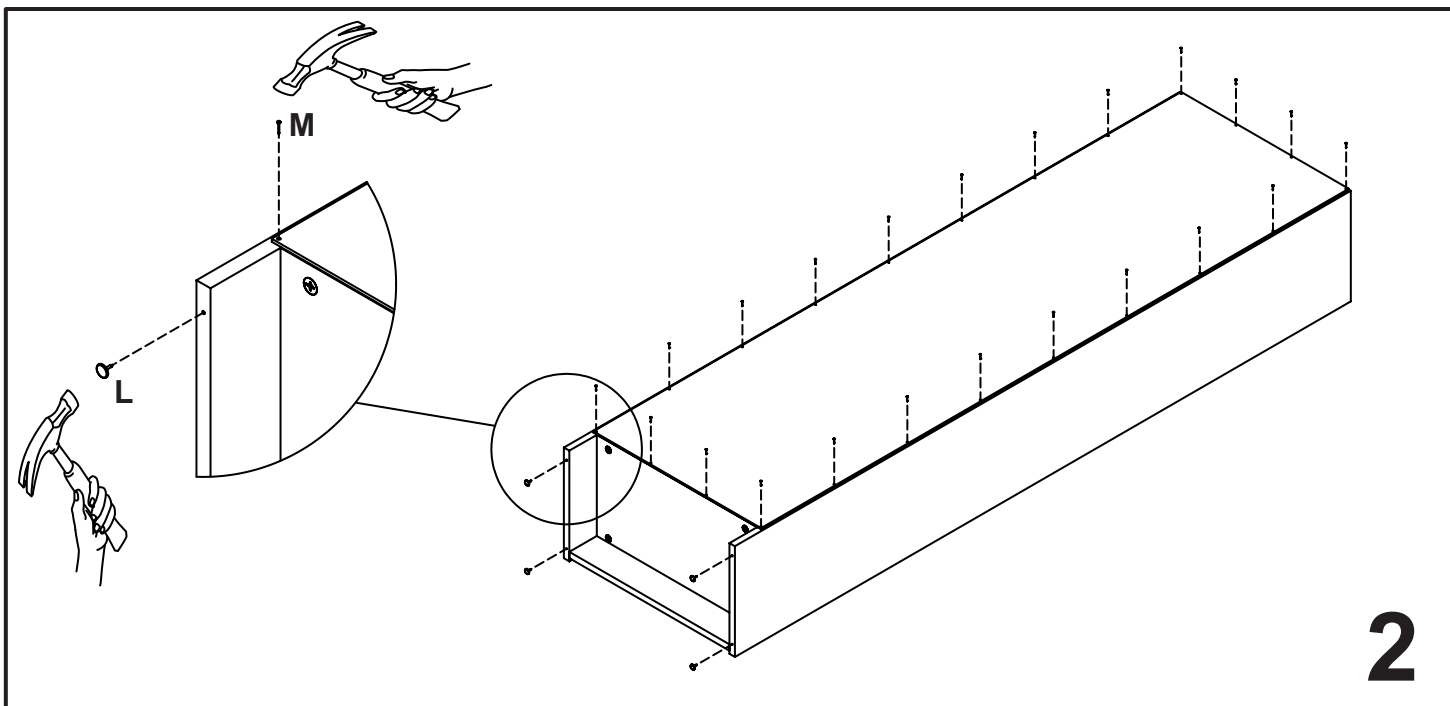

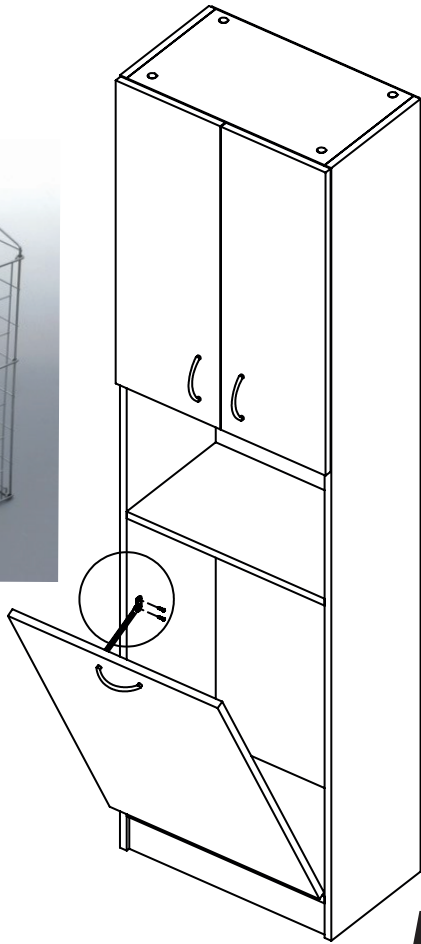
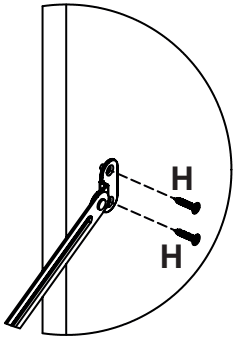
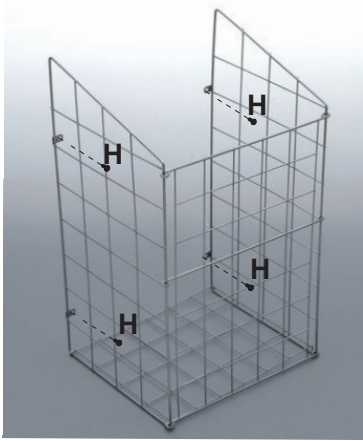

5

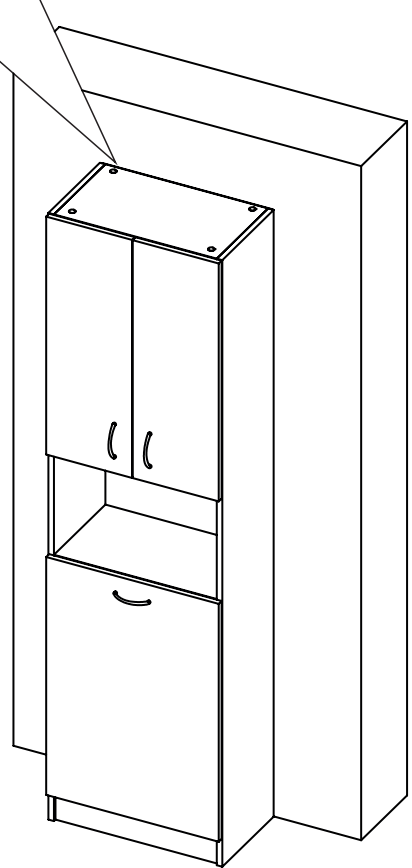
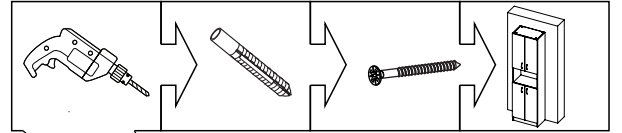

6

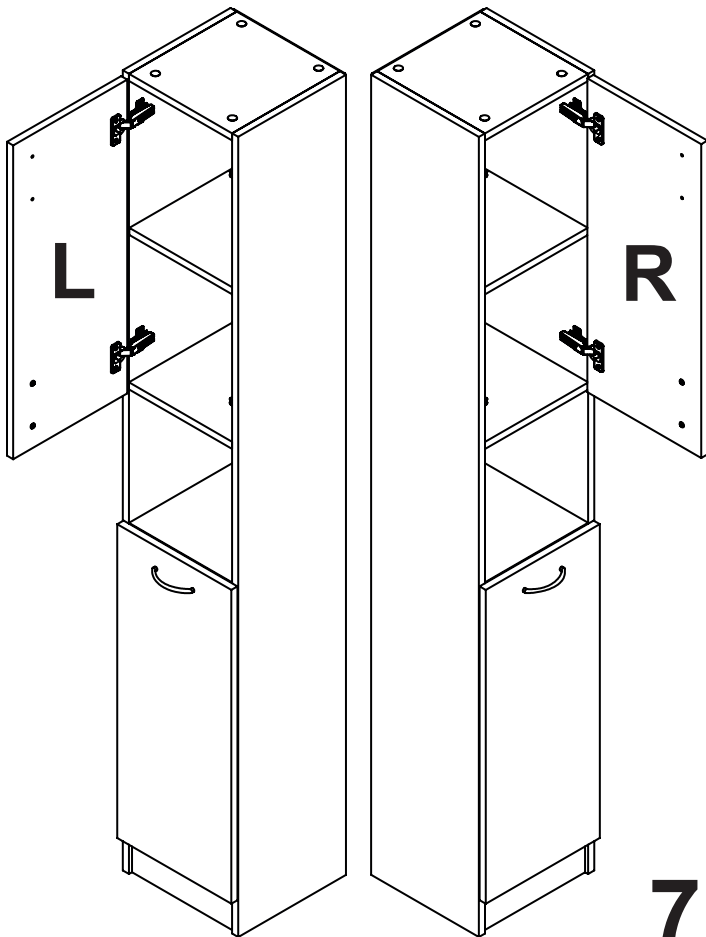

7

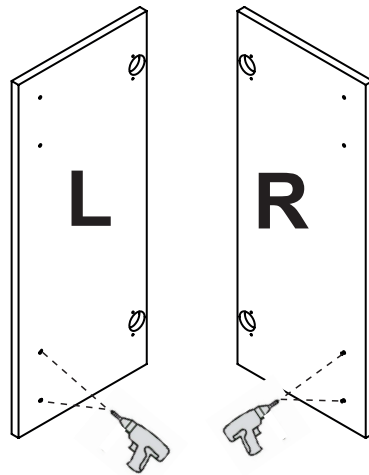

8

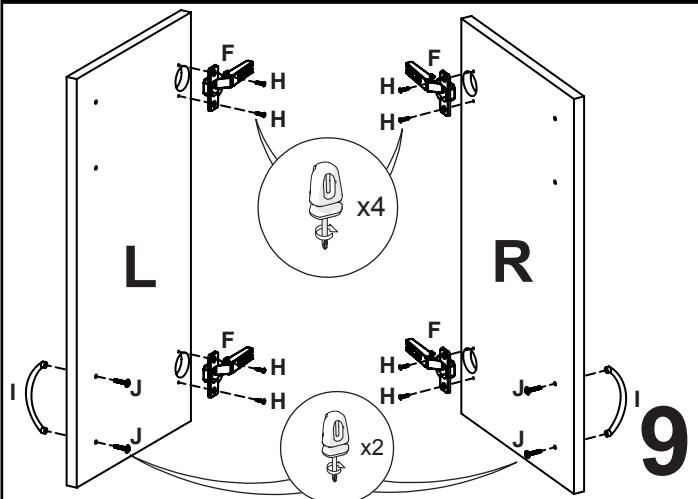

9