

# Montážní návod Assembly instruction

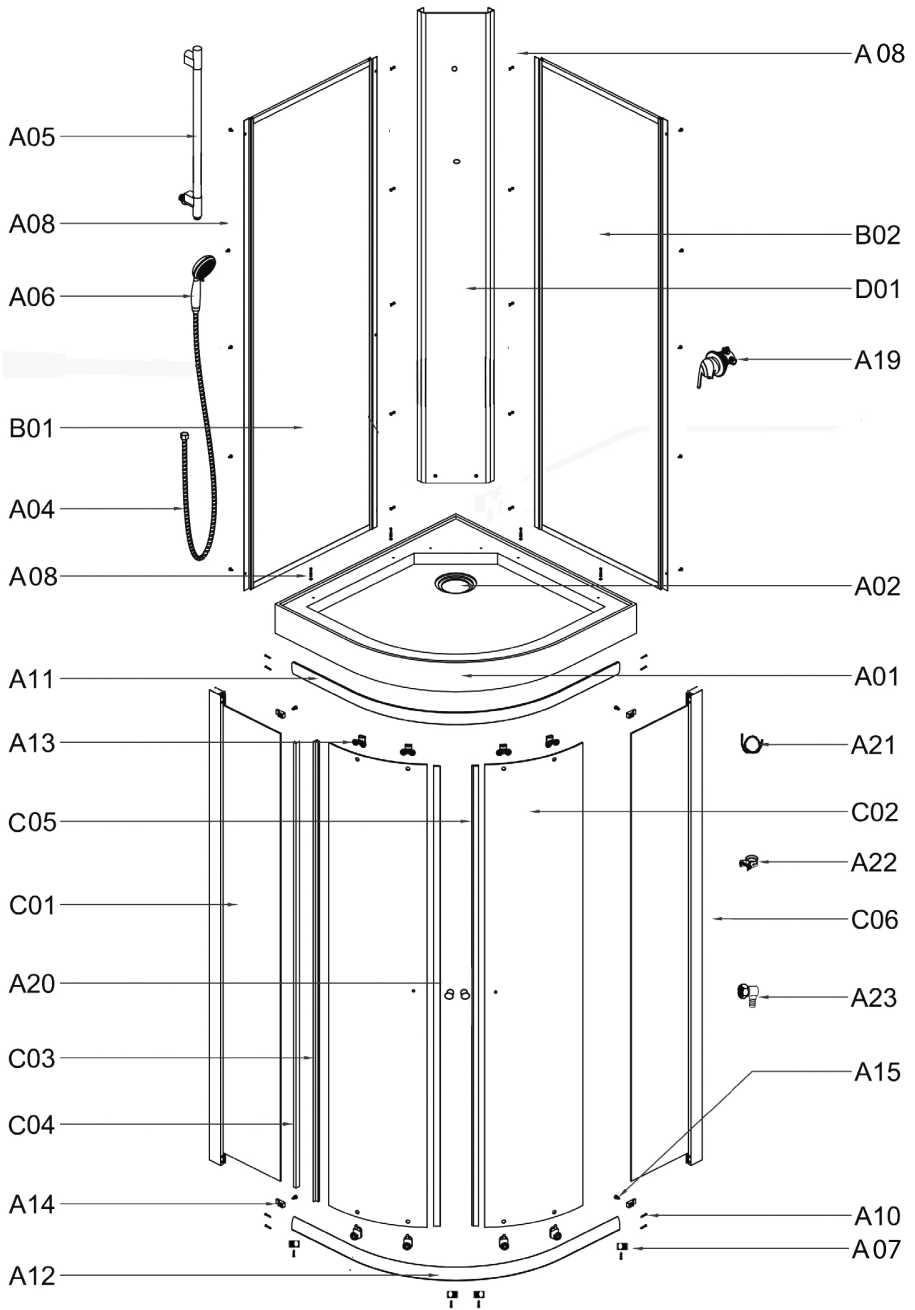

## YB93





Tool:

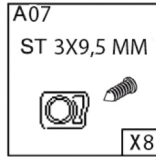
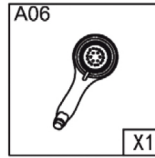
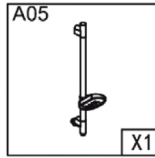
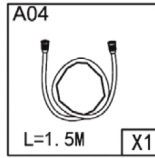
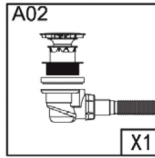
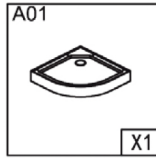
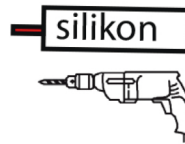
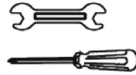

1/4

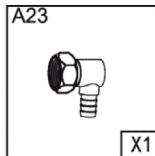
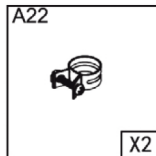
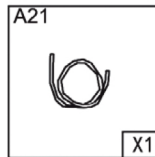
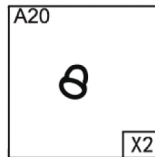
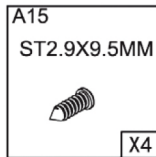
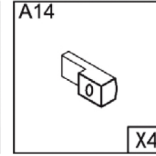
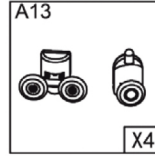
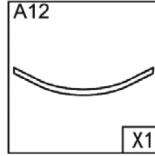
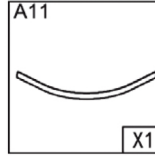
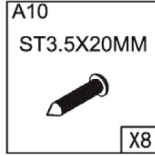
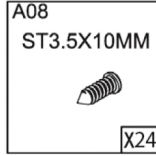

2/4

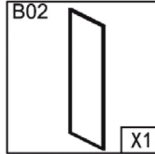
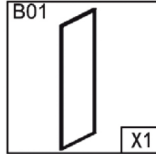

3/4

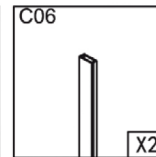
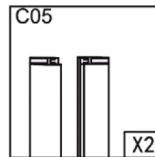
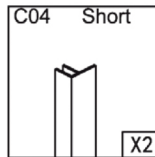
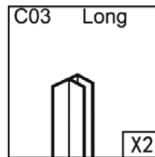
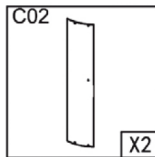
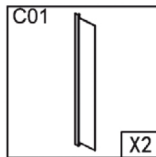

4/4

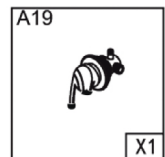
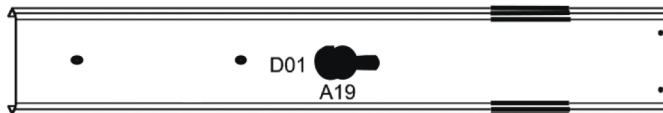

A01







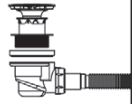

X1

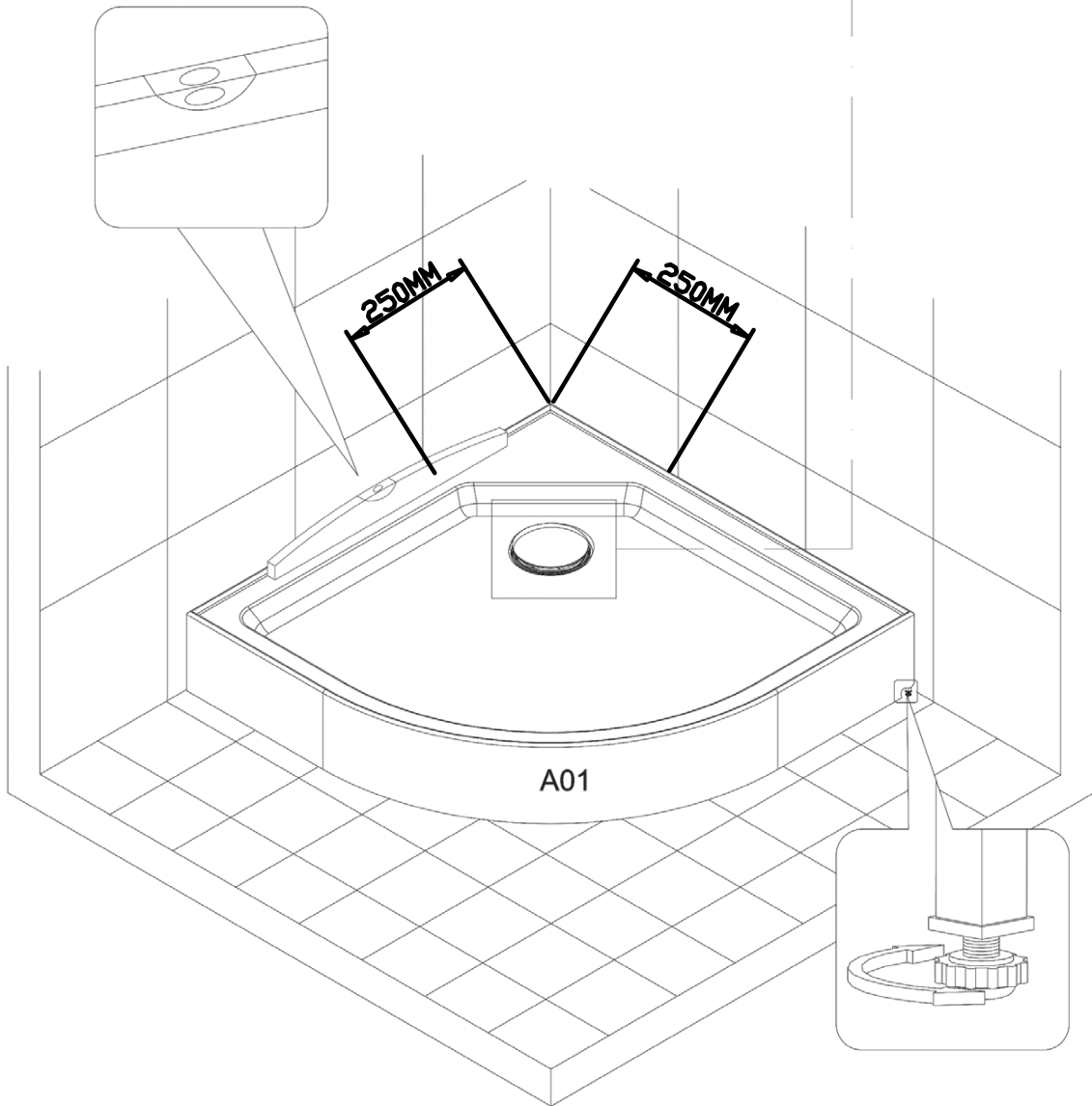
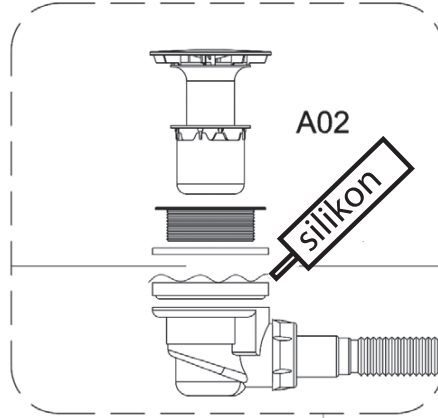
A02









X1

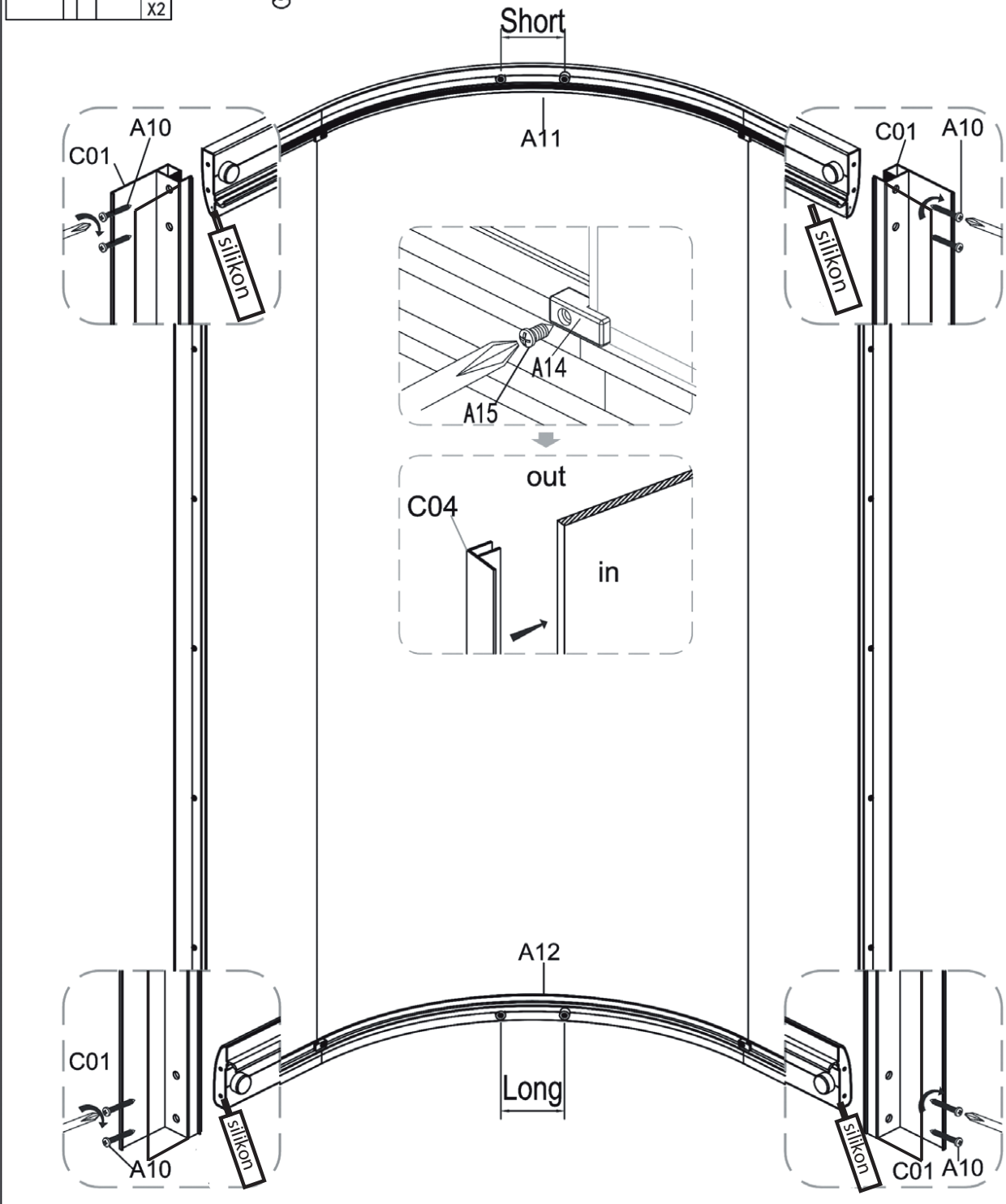

|   |  |  |  |  |   |
|---|--|--|--|--|---|
| <p>A10</p>  <p>ST3.5X20MM X8</p> | <p>C01</p>  <p>X2</p> | <p>A11</p>  <p>X1</p> | <p>A12</p>  <p>X1</p> | <p>A14</p>  <p>X4</p> | <p>A15</p> <p>ST2.9X9.5MM</p>  <p>X4</p> |
|---|--|--|--|--|---|

|  |
|--|
| <p>C04 Short</p>  <p>X2</p> |
|--|



|  |  |  |   |  |
|--|--|--|---|--|
| <p>A13</p>  <p>X4</p> | <p>A20</p>  <p>X2</p> | <p>C02</p>  <p>X2</p> | <p>C03 Long</p>  <p>X2</p> | <p>C05</p>  <p>X1</p> |
|--|--|--|---|--|

