

# **URBAN CHIC**

---

COLLEZIONE **2018**



[www.forteboxdoccia.it](http://www.forteboxdoccia.it)

---

# EXPRESS YOU STYLE

Lasciatevi ispirare da tutto un ventaglio di possibilità  
per esternare liberamente la vostra personalità e celebrare  
ogni giorno il vostro stile di vita personale.

---

---

L'appeal magnetico della geometria applicata al design d'interni.  
Con la linea Urban cerchiamo di rispondere al bisogno di dare spazio  
alla propria voglia di esprimersi e di saper vivere.  
Abbiamo creato elementi di design che con la loro peculiare estetica  
spigolosamente geometrica sfidano il costante progresso.



# LOVE FOR DETAILS

La cura dei dettagli e la combinazione con le esigenze funzionali, ci permette di garantirvi un prodotto unico e dall'eleganza essenziale.

- Sistema di sgancio rapido inferiore del cristallo;
- Pulizia agevolata;
- Estensibile;
- Montante con fissaggio a muro a scomparsa per un'estetica essenziale e senza sbavature.

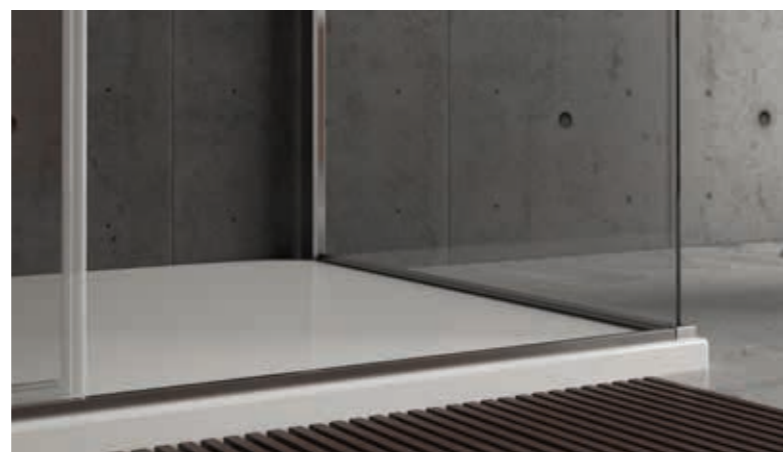

# URBAN ESSENCE



---

Un binario di scorrimento inferiore in alluminio con altezza massima 11,5 mm a sostegno dei modelli essence.

Adatti tanto ai corner quanto alle nicchie, i box della linea Urban Essence vantano un'altezza di 2 metri.

# La nuova Cover XL

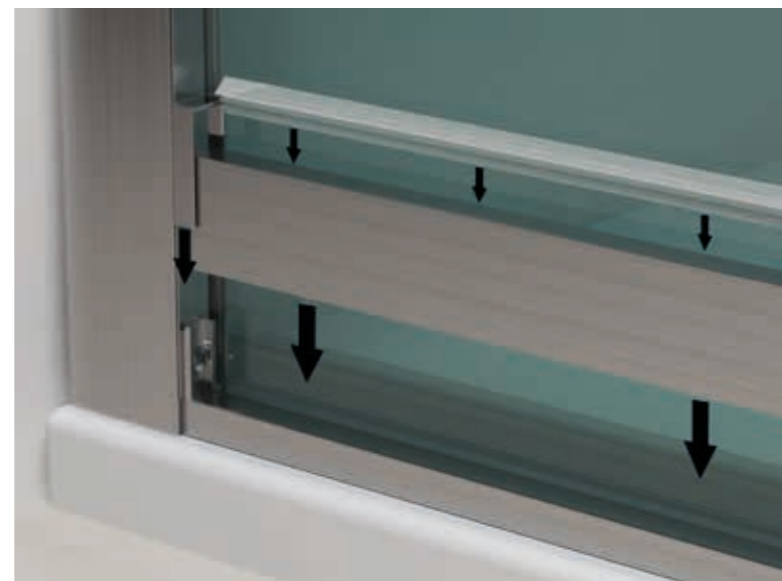

Cover XL è il Kit che ti consente di aumentare con un click l'altezza del binario inferiore sino a 34 mm.

Montaggio semplice, veloce e pulito, per un'estetica unica, essenziale e funzionale.

Il Kit Cover XL è un kit universale abbinabile a qualsiasi tipo di box doccia a catalogo.

• 1 KIT comprende

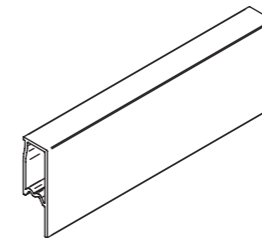

**SL10T07**  
1pz da 2 metri  
o 2pz da 2 metri



**BA6009**  
1pz da 2 metri  
o 2pz da 2 metri



**SL2022**  
2 pz



**SL2023**  
1 pz



**SL2024**  
1 pz

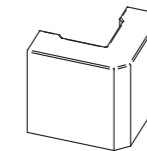

**SL2025**  
1 pz

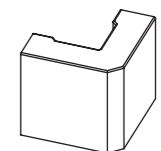

**SL2029**  
2 pz

\*Per i dettagli dei prezzi si vda a pag. 49



Urban ESSENCE con applicazione Cover XL

# URBAN ESSENCE INDEX

NICCHIE.

**ESSENCE N1FS**  
pag. 27

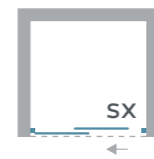
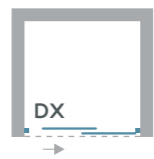

**ESSENCE N2FS**  
pag. 35

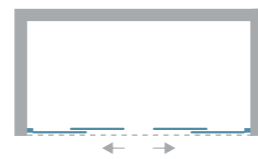

ANGOLI.  
CORNERS.

**ESSENCE A1FS**  
pag. 22

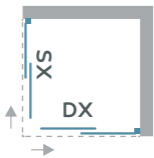

COMBINAZIONE  
CON ANTA FISSA.  
IN COMBINATION  
WITH FIXED PANEL

**ESSENCE N1FS + F1**  
pag. 28

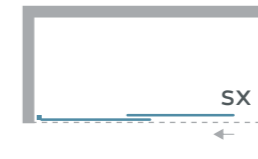

**ESSENCE N2FS + F1**  
pag. 36

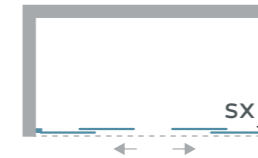

PENISOLE

**ESSENCE A1FS + F1**  
pag. 24

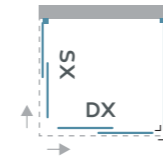

**ESSENCE N1FS + 2F1**  
pag. 32

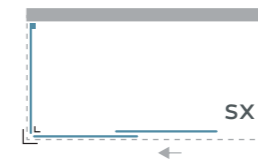

**ESSENCE N2FS + 2F1**  
pag. 39

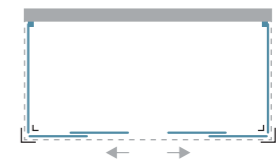



# URBAN ESSENCE INDEX

## COLORI. COLOURS.

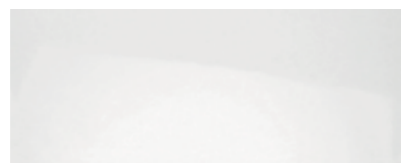

215 Bianco RAL 9010



348 Ossidato

LUCIDO

## PANNELLI. PANELS.



104 Trasparente  
103 Trasparente Aqua Clen  
Cristallo temperato 6 mm.  
Peso al m<sup>2</sup>: 15 kg

Trasparent  
6mm Tempered glass.  
Weight per m<sup>2</sup>: 15 kg



401 Cincillà  
400 Cincillà Aqua Clen  
Cristallo temperato 6 mm.  
Peso al m<sup>2</sup>: 15 kg

Chinchilla  
6mm Tempered glass.  
Weight per m<sup>2</sup>: 15 kg



501 Acidato  
500 Acidato Aqua Clen  
Cristallo temperato 6 mm.  
Peso al m<sup>2</sup>: 15 kg

Frosted  
6mm Tempered glass.  
Weight per m<sup>2</sup>: 15 kg



# GUIDA ALL'ACQUISTO

SCEGLI LA GIUSTA MISURA  
DELLA TUA CABINA DOCCIA FORTE

La scelta del box doccia è dettata normalmente dalla forma e dalle misure del piatto doccia sul quale il box sarà installato, specie in caso di abbinamento ad anta fissa F1.

Vi proponiamo di seguito degli esempi di installazione su piatto doccia dei modelli:

- A1FS
- N1FS
- N2FS

che ci aiuteranno a comprendere quale sarà la misura giusta da scegliere per il nostro box doccia.

Vi invitiamo a considerare che le misure del Vostro box doccia varieranno anche in base all'eventuale combinazione con Anta Fissa F1.

## ESEMPIO DI INSTALLAZIONE SU PIATTO DOCCIA DI UNA CABINA ANGOLARE E RELATIVE MISURE A1FS

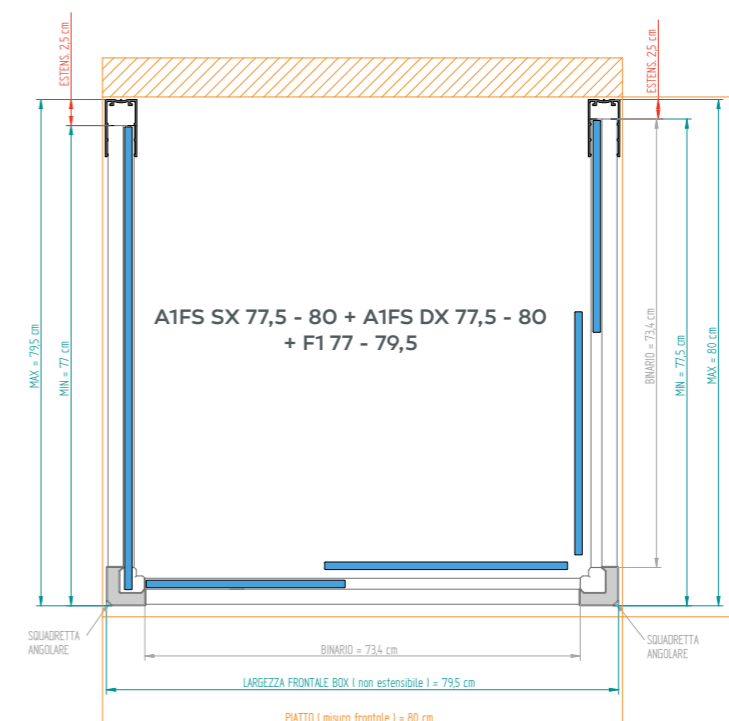
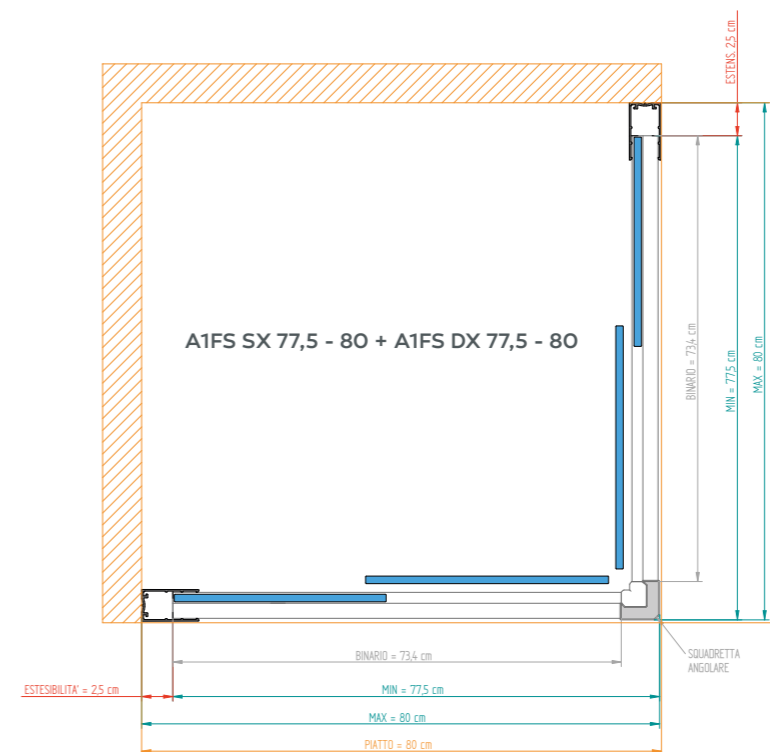

ESEMPIO DI INSTALLAZIONE SU PIATTO DOCCIA DI UNA CABINA CON APERTURA LATERALE E RELATIVE MISURE  
**N1FS**

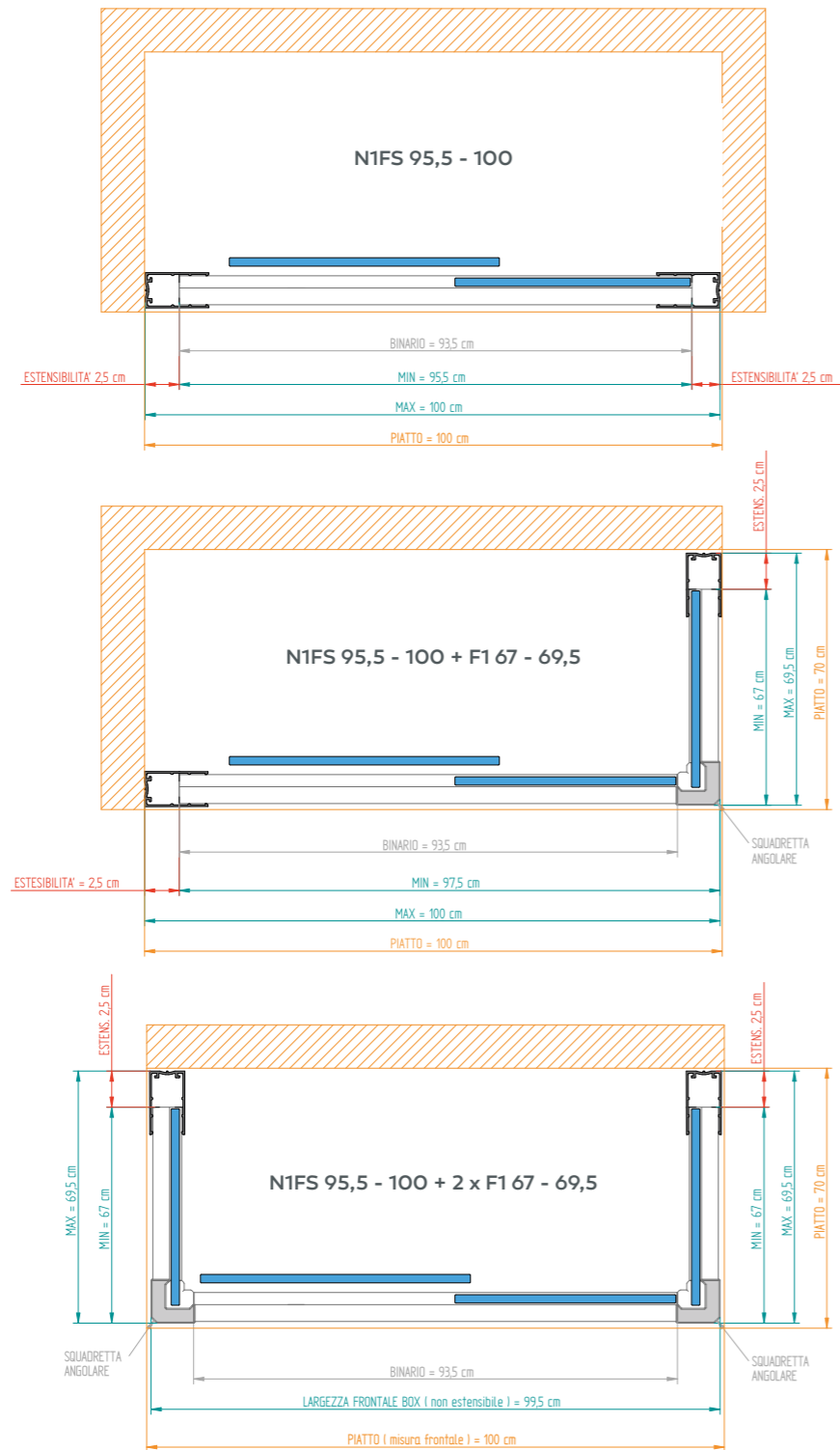

ESEMPIO DI INSTALLAZIONE SU PIATTO DOCCIA DI UNA CABINA CON APERTURA CENTRALE E RELATIVE MISURE  
**N2FS**

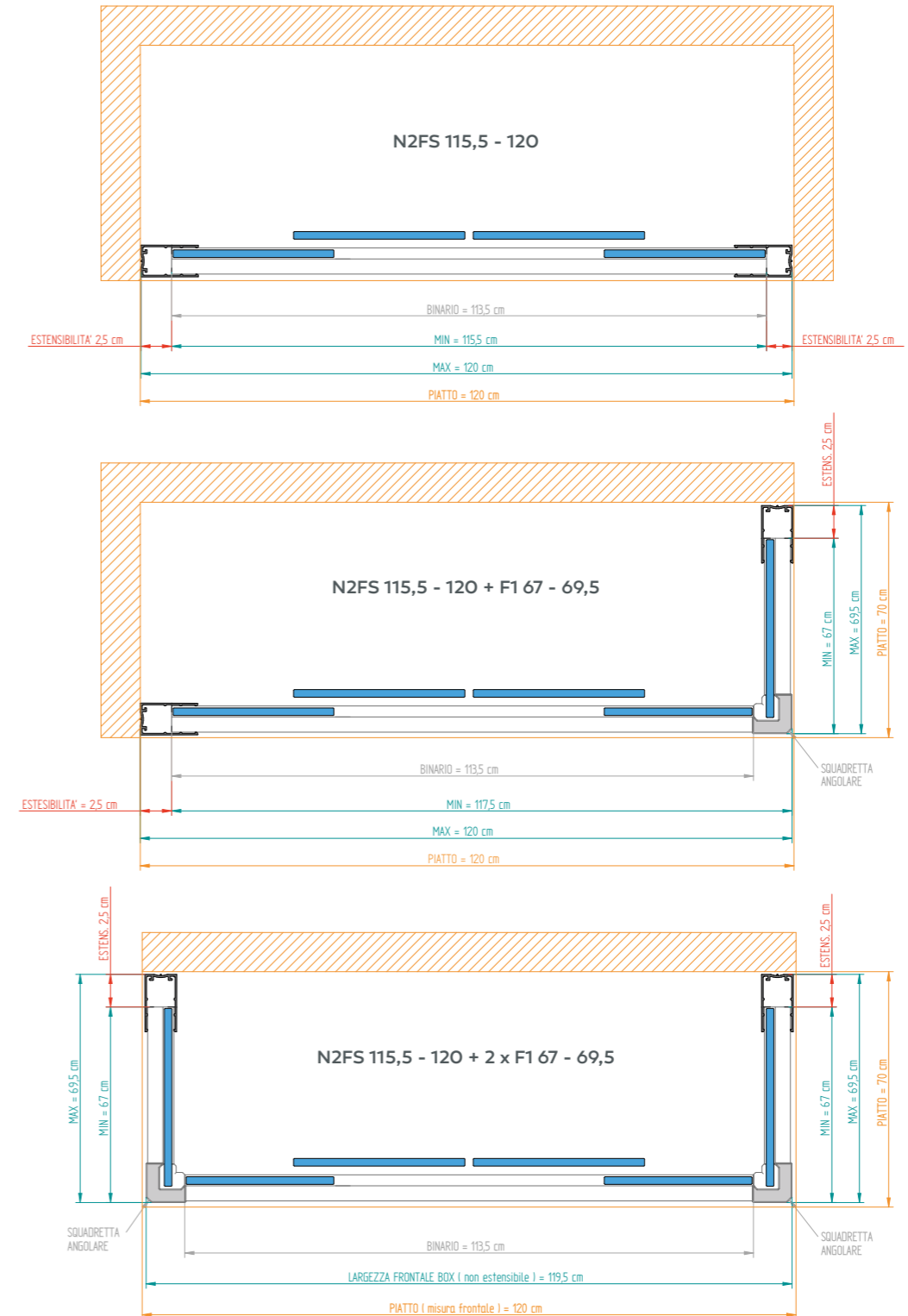

# URBAN ESSENCE A1FS

ANGOLO A QUATTRO ANTE.  
CORNER WITH TWO SLIDING DOOR.

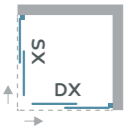

## ESSENCE A1FS

½ LATO

CODICE	ESTENSIBILITÀ STANDARD	INGR.	COLORE	TRASP.	CINCILLÀ	ACIDATO	COLLI
BEA10 DX / SX	67,5 - 70	37	Bianco	€ 215	€ 232	€ 282	1
			Ossidato lucido	€ 233	€ 251	€ 300	
BEA11 DX / SX	72,5 - 75	40	Bianco	€ 218	€ 238	€ 289	1
			Ossidato lucido	€ 237	€ 256	€ 308	
BEA12 DX / SX	77,5 - 80	44	Bianco	€ 224	€ 245	€ 303	1
			Ossidato lucido	€ 243	€ 264	€ 322	
BEA13 DX / SX	87,5 - 90	51	Bianco	€ 233	€ 257	€ 318	1
			Ossidato lucido	€ 253	€ 276	€ 337	
BEA14 DX / SX	97,5 - 100	58	Bianco	€ 243	€ 269	€ 333	1
			Ossidato lucido	€ 263	€ 289	€ 352	
BEA15 DX / SX	117,5 - 120	72	Bianco	€ 264	€ 295	€ 375	1
			Ossidato lucido	€ 284	€ 316	€ 395	

### NOTA

Prezzi validi per la vendita del ½ lato.  
Per una composizione corretta della cabina doccia è necessario ordinare set di n°2 ½ lati.



+ € 90 per trattamento aqvaclean su ½ LATO A1FS.  
(for aqvaclean treatment on A1FS).



### DIMENSIONE PROFILI A PARETE. DIMENSIONS OF PROFILES AT THE WALL.

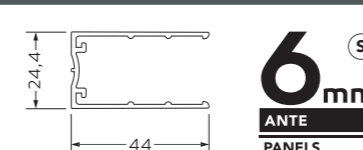

### CONDIZIONI FUORI MISURA CONDITIONS FOR CUSTOM SIZE

A1FS
H max 220 cm
L min 50 cm
L max 135 cm
Maggiorazione del 30% per fuorimisura 30% surcharge for non standard

# URBAN ESSENCE A1FS + F1

ANGOLO A QUATTRO ANTE + ANTA FISSA.  
CORNER WITH TWO SLIDING DOOR COMBINABLE WITH FIXED PANEL.

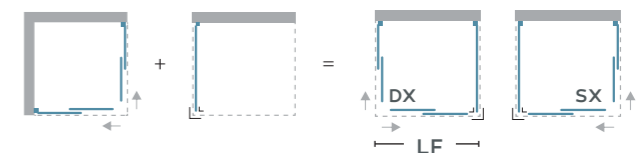

## ESSENCE A1FS (abbinamento ad un'anta fissa)

½ LATO

CODICE	ESTENSIBILITA'		INGR.	COLORE	TRASP.	CINCILLÀ	ACIDATO	COLLI
	STANDARD (LATO A MURO)	LATO FRONTALE						
BEA10 DX / SX	67,5 - 70	70	37	Bianco	€ 215	€ 232	€ 282	1
				Ossidato lucido	€ 233	€ 251	€ 300	
BEA11 DX / SX	72,5 - 75	75	40	Bianco	€ 218	€ 238	€ 289	1
				Ossidato lucido	€ 237	€ 256	€ 308	
BEA12 DX / SX	77,5 - 80	80	44	Bianco	€ 224	€ 245	€ 303	1
				Ossidato lucido	€ 243	€ 264	€ 322	
BEA13 DX / SX	87,5 - 90	90	51	Bianco	€ 233	€ 257	€ 318	1
				Ossidato lucido	€ 253	€ 276	€ 337	
BEA14 DX / SX	97,5 - 100	100	58	Bianco	€ 243	€ 269	€ 333	1
				Ossidato lucido	€ 263	€ 289	€ 352	
BEA15 DX / SX	117,5 - 120	120	72	Bianco	€ 264	€ 295	€ 375	1
				Ossidato lucido	€ 284	€ 316	€ 395	

**NOTA**  
LF\* - Nell'abbinamento ad Ante Fissa la lunghezza frontale della cabina resta fissa.  
Prezzi validi per la vendita del ½ lato.  
Per una composizione corretta della cabina doccia è necessario ordinare set di n°2 ½ lati.

**OPTIONAL AQVAclean** + € 90 per trattamento aqvaclean su ½ LATO A1FS. (for aqvaclean treatment on A1FS).

## ESSENCE F1

ANTA FISSA

CODICE	ESTENSIBILITÀ STANDARD	INGR.	COLORE	TRASP.	CINCILLÀ	ACIDATO	COLLI
BEF10	67 - 69,5	-	Bianco	€ 180	€ 200	€ 223	1
			Ossidato lucido	€ 195	€ 217	€ 240	
BEF11	72 - 74,5	-	Bianco	€ 185	€ 209	€ 231	1
			Ossidato lucido	€ 201	€ 225	€ 247	
BEF12	77 - 79,5	-	Bianco	€ 193	€ 219	€ 246	1
			Ossidato lucido	€ 209	€ 235	€ 262	
BEF13	87 - 89,5	-	Bianco	€ 204	€ 234	€ 261	1
			Ossidato lucido	€ 221	€ 250	€ 278	

**OPTIONAL AQVAclean** + € 90 per trattamento aqvaclean su F1. (for aqvaclean treatment on F1).

DIMENSIONE PROFILI A PARETE.  
DIMENSIONS OF PROFILES AT THE WALL.

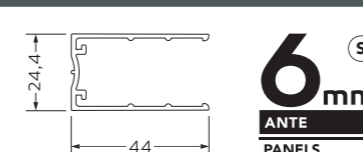

CONDIZIONI FUORI MISURA  
CONDITIONS FOR CUSTOM SIZE

A1FS	F1
H max 220 cm	H max 220 cm
L min 50 cm	L min 20 cm
L max 135 cm	L max 135 cm
Maggiorazione del 30% per fuorimisura 30% surcharge for non standard	

# URBAN ESSENCE *N1FS*

PORTA SCORREVOLE A DUE ANTE.  
TWO PANELS WITH SLIDING DOORL.

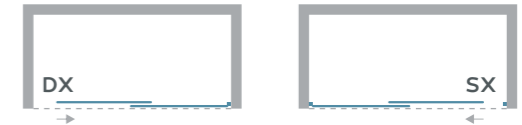

## ESSENCE *N1FS*

CABINA

CODICE	ESTENSIBILITÀ STANDARD	INGR.	COLORE	TRASP.	CINCILLÀ	ACIDATO	COLLI
BEN10 DX / SX	95,5 - 100	38	Bianco	€ 284	€ 316	€ 354	1
			Ossidato lucido	€ 312	€ 345	€ 382	
BEN11 DX / SX	105,5 - 110	43	Bianco	€ 295	€ 331	€ 369	1
			Ossidato lucido	€ 323	€ 359	€ 397	
BEN12 DX / SX	115,5 - 120	48	Bianco	€ 309	€ 348	€ 396	1
			Ossidato lucido	€ 337	€ 377	€ 425	
BEN13 DX / SX	125,5 - 130	53	Bianco	€ 341	€ 385	€ 433	2
			Ossidato lucido	€ 370	€ 414	€ 462	
BEN14 DX / SX	135,5 - 140	58	Bianco	€ 344	€ 389	€ 438	2
			Ossidato lucido	€ 371	€ 418	€ 466	
BEN15 DX / SX	145,5 - 150	63	Bianco	€ 355	€ 404	€ 452	2
			Ossidato lucido	€ 384	€ 432	€ 481	
BEN16 DX / SX	155,5 - 160	68	Bianco	€ 369	€ 422	€ 478	2
			Ossidato lucido	€ 398	€ 451	€ 509	



+ € 90 per trattamento aquaclean su N1FS.  
(for aquaclean treatment on N1FS).



DIMENSIONE PROFILI A PARETE.  
DIMENSIONS OF PROFILES AT THE WALL.

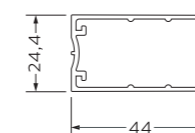

**6** mm  
ANTE  
PANELS

CONDIZIONI FUORI MISURA  
CONDITIONS FOR CUSTOM SIZE

N1FS

H max 220 cm

L min 80 cm

L max 200 cm

Maggiorazione del 30% per fuorimisura  
30% surcharge for non standard

# URBAN ESSENCE N1FS + F1

PORTA SCORREVOLE A DUE ANTE ABBINABILE AD ANTA FISSA.  
TWO PANELS WITH SLIDING DOOR COMBINABLE WITH FIXED PANEL

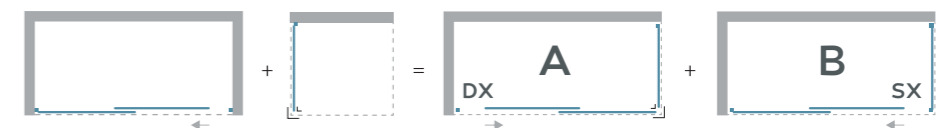

## ESSENCE N1FS (abbinamento ad un'anta fissa)

CABINA

CODICE	ESTENSIBILITÀ		INGR.	COLORE	TRASP.	CINCILLÀ	ACIDATO	COLLI
	STANDARD	ABBINATO A F1						
BEN10 DX / SX	95,5 - 100	97,5 - 100	38	Bianco	€ 284	€ 316	€ 354	1
				Ossidato lucido	€ 312	€ 345	€ 382	
BEN11 DX / SX	105,5 - 110	107,5 - 110	43	Bianco	€ 295	€ 331	€ 369	1
				Ossidato lucido	€ 323	€ 359	€ 397	
BEN12 DX / SX	115,5 - 120	117,5 - 120	48	Bianco	€ 309	€ 348	€ 396	1
				Ossidato lucido	€ 337	€ 377	€ 425	
BEN13 DX / SX	125,5 - 130	127,5 - 130	53	Bianco	€ 341	€ 385	€ 433	2
				Ossidato lucido	€ 370	€ 414	€ 462	
BEN14 DX / SX	135,5 - 140	137,5 - 140	58	Bianco	€ 344	€ 389	€ 438	2
				Ossidato lucido	€ 371	€ 418	€ 466	
BEN15 DX / SX	145,5 - 150	147,5 - 150	63	Bianco	€ 355	€ 404	€ 452	2
				Ossidato lucido	€ 384	€ 432	€ 481	
BEN16 DX / SX	155,5 - 160	157,5 - 160	68	Bianco	€ 369	€ 422	€ 478	2
				Ossidato lucido	€ 398	€ 451	€ 509	

**OPTIONAL AQVAclean** + € 90 per trattamento aqvaclean su N1FS.  
(for aqvaclean treatment on N1FS).

## ESSENCE F1

ANTA FISSA

CODICE	ESTENSIBILITÀ STANDARD	INGR.	COLORE	TRASP.	CINCILLÀ	ACIDATO	COLLI
BEF10	67 - 69,5	-	Bianco	€ 180	€ 200	€ 223	1
			Ossidato lucido	€ 195	€ 217	€ 240	
BEF11	72 - 74,5	-	Bianco	€ 185	€ 209	€ 231	1
			Ossidato lucido	€ 201	€ 225	€ 247	
BEF12	77 - 79,5	-	Bianco	€ 193	€ 219	€ 246	1
			Ossidato lucido	€ 209	€ 235	€ 262	
BEF13	87 - 89,5	-	Bianco	€ 204	€ 234	€ 261	1
			Ossidato lucido	€ 221	€ 250	€ 278	

**OPTIONAL AQVAclean** + € 90 per trattamento aqvaclean su F1.  
(for aqvaclean treatment on F1).

### DIMENSIONE PROFILI A PARETE. DIMENSIONS OF PROFILES AT THE WALL.

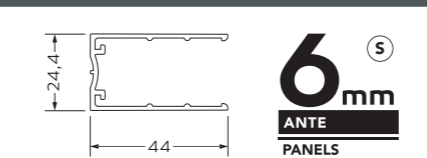

### CONDIZIONI FUORI MISURA CONDITIONS FOR CUSTOM SIZE

N1FS	F1
H max 220 cm	H max 220 cm
L min 80 cm	L min 20 cm
L max 200 cm	L max 135 cm

Maggiorazione del 30% per fuorimisura  
30% surcharge for non standard





# URBAN ESSENCE N1FS + 2F1

PORTA SCORREVOLE A DUE ANTE ABBINABILE AD ANTA FISSA.  
TWO PANELS WITH SLIDING DOOR COMBINABLE WITH FIXED PANEL

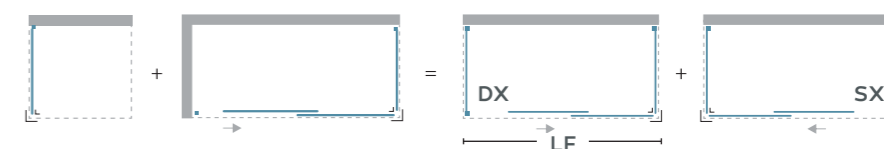

## ESSENCE N1FS (abbinamento a due ante fisse)

CABINA

CODICE	ESTENSIBILITÀ		INGR.	COLORE	TRASP.	CINCILLÀ	ACIDATO	COLLI
	STANDARD	ABBINATO A F1						
BEN10 DX / SX	95,5 - 100	100	38	Bianco	€ 284	€ 316	€ 354	1
				Ossidato lucido	€ 312	€ 345	€ 382	
BEN11 DX / SX	105,5 - 110	110	43	Bianco	€ 295	€ 331	€ 369	1
				Ossidato lucido	€ 323	€ 359	€ 397	
BEN12 DX / SX	115,5 - 120	120	48	Bianco	€ 309	€ 348	€ 396	1
				Ossidato lucido	€ 337	€ 377	€ 425	
BEN13 DX / SX	125,5 - 130	130	53	Bianco	€ 341	€ 385	€ 433	2
				Ossidato lucido	€ 370	€ 414	€ 462	
BEN14 DX / SX	135,5 - 140	140	58	Bianco	€ 344	€ 389	€ 438	2
				Ossidato lucido	€ 371	€ 418	€ 466	
BEN15 DX / SX	145,5 - 150	150	63	Bianco	€ 355	€ 404	€ 452	2
				Ossidato lucido	€ 384	€ 432	€ 481	
BEN16 DX / SX	155,5 - 160	160	68	Bianco	€ 369	€ 422	€ 478	2
				Ossidato lucido	€ 398	€ 451	€ 509	

### NOTA

LF\*- Nell'abbinamento a due Ante Fisse la lunghezza frontale della cabina resta fissa.



OPTIONAL  
AQUAclean

+ € 90 per trattamento aqvaclean su N1FS.  
(for aqvaclean treatment on N1FS).

## ESSENCE F1

ANTA FISSA

CODICE	ESTENSIBILITÀ STANDARD	INGR.	COLORE	TRASP.	CINCILLÀ	ACIDATO	COLLI
BEF10	67 - 69,5	-	Bianco	€ 180	€ 200	€ 223	1
			Ossidato lucido	€ 195	€ 217	€ 240	
BEF11	72 - 74,5	-	Bianco	€ 185	€ 209	€ 231	1
			Ossidato lucido	€ 201	€ 225	€ 247	
BEF12	77 - 79,5	-	Bianco	€ 193	€ 219	€ 246	1
			Ossidato lucido	€ 209	€ 235	€ 262	
BEF13	87 - 89,5	-	Bianco	€ 204	€ 234	€ 261	1
			Ossidato lucido	€ 221	€ 250	€ 278	

### NOTA

Per una composizione corretta del box a due ante fisse è necessario calcolare X2 F1 i prezzi del listino



OPTIONAL  
AQUAclean

+ € 90 per trattamento aqvaclean su F1.  
(for aqvaclean treatment on F1).

### DIMENSIONE PROFILI A PARETE. DIMENSIONS OF PROFILES AT THE WALL.

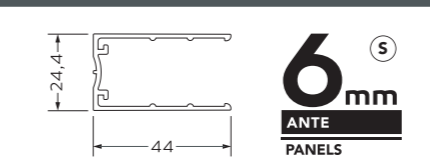

6<sup>mm</sup>  
ANTE  
PANELS

### CONDIZIONI FUORI MISURA CONDITIONS FOR CUSTOM SIZE

N1FS	F1
H max 220 cm	H max 220 cm
L min 80 cm	L min 20 cm
L max 200 cm	L max 135 cm
Maggiorazione del 30% per fuorimisura 30% surcharge for non standard	

# URBAN ESSENCE N2FS

PORTA SCORREVOLE A QUATTRO ANTE ABBINABILE AD ANTA FISSA.  
FOUR PANELS WITH TWO SLIDING DOOR COMBINABLE WITH FIXED PANEL.

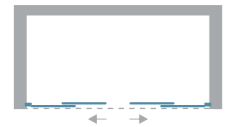

## ESSENCE N2FS

CABINA

CODICE	ESTENSIBILITÀ STANDARD	INGR.	COLORE	TRASP.	CINCILLÀ	ACIDATO	COLLI
BEN20	115,5 - 120	46	Bianco	€ 379	€ 421	€ 485	2
			Ossidato lucido	€ 414	€ 456	€ 520	
BEN21	125,5 - 130	51	Bianco	€ 387	€ 432	€ 487	2
			Ossidato lucido	€ 423	€ 467	€ 522	
BEN22	135,5 - 140	56	Bianco	€ 401	€ 450	€ 515	2
			Ossidato lucido	€ 437	€ 486	€ 551	
BEN23	145,5 - 150	61	Bianco	€ 412	€ 465	€ 530	2
			Ossidato lucido	€ 448	€ 500	€ 567	
BEN24	155,5 - 160	66	Bianco	€ 424	€ 479	€ 546	2
			Ossidato lucido	€ 460	€ 515	€ 582	
BEN25	165,5 - 170	71	Bianco	€ 437	€ 497	€ 574	2
			Ossidato lucido	€ 474	€ 534	€ 610	



+ € 90 per trattamento aquaclean su N2FS.  
(for aquaclean treatment on N2FS).



### DIMENSIONE PROFILI A PARETE. DIMENSIONS OF PROFILES AT THE WALL.

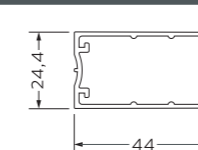

**6** <sup>S</sup>  
mm  
ANTE  
PANELS

### CONDIZIONI FUORI MISURA CONDITIONS FOR CUSTOM SIZE

N2FS
H max 220 cm
L min 80 cm
L max 200 cm
Maggiorazione del 30% per fuorimisura 30% surcharge for non standard

# URBAN ESSENCE N2FS + F1

PORTA SCORREVOLE A QUATTRO ANTE ABBINABILE AD ANTA FISSA.  
FOUR PANELS WITH TWO SLIDING DOOR COMBINABLE WITH FIXED PANEL.

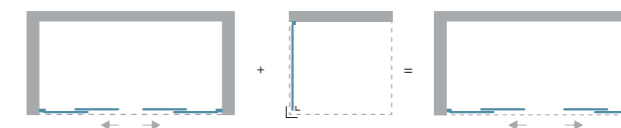

## ESSENCE N2FS (abbinamento ad un'anta fissa)

CABINA

CODICE	ESTENSIBILITÀ		INGR.	COLORE	TRASP.	CINCILLÀ	ACIDATO	COLLI
	STANDARD	ABBINATO A F1						
BEN20	115,5 - 120	117,5 - 120	46	Bianco	€ 379	€ 421	€ 485	2
				Ossidato lucido	€ 414	€ 456	€ 520	
BEN21	125,5 - 130	127,5 - 130	51	Bianco	€ 387	€ 432	€ 487	2
				Ossidato lucido	€ 423	€ 467	€ 522	
BEN22	135,5 - 140	137,5 - 140	56	Bianco	€ 401	€ 450	€ 515	2
				Ossidato lucido	€ 437	€ 486	€ 551	
BEN23	145,5 - 150	147,5 - 150	61	Bianco	€ 412	€ 465	€ 530	2
				Ossidato lucido	€ 448	€ 500	€ 567	
BEN24	155,5 - 160	157,5 - 160	66	Bianco	€ 424	€ 479	€ 546	2
				Ossidato lucido	€ 460	€ 515	€ 582	
BEN25	165,5 - 170	167,5 - 170	71	Bianco	€ 437	€ 497	€ 574	2
				Ossidato lucido	€ 474	€ 534	€ 610	

**OPTIONAL AQVAclean** + € 90 per trattamento aqvaclean su N2FS.  
(for aqvaclean treatment on N2FS).

## ESSENCE F1

ANTA FISSA

CODICE	ESTENSIBILITÀ STANDARD	INGR.	COLORE	TRASP.	CINCILLÀ	ACIDATO	COLLI
BEF11	72 - 74,5	-	Bianco	€ 185	€ 209	€ 231	1
			Ossidato lucido	€ 201	€ 225	€ 247	
BEF12	77 - 79,5	-	Bianco	€ 193	€ 219	€ 246	1
			Ossidato lucido	€ 209	€ 235	€ 262	
BEF13	87 - 89,5	-	Bianco	€ 204	€ 234	€ 261	1
			Ossidato lucido	€ 221	€ 250	€ 278	

**OPTIONAL AQVAclean** + € 90 per trattamento aqvaclean su F1.  
(for aqvaclean treatment on F1).

### DIMENSIONE PROFILI A PARETE. DIMENSIONS OF PROFILES AT THE WALL.

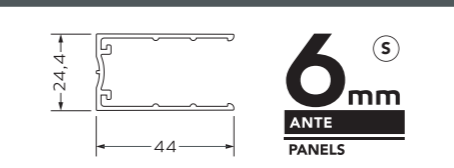

### CONDIZIONI FUORI MISURA CONDITIONS FOR CUSTOM SIZE

N2FS	F1
H max 220 cm	H max 220 cm
L min 80 cm	L min 20 cm
L max 200 cm	L max 135 cm

Maggiorazione del 30% per fuorimisura  
30% surcharge for non standard

# URBAN ESSENCE N2FS + 2F1

PORTA SCORREVOLE A QUATTRO ANTE ABBINABILE AD ANTA FISSA.  
FOUR PANELS WITH TWO SLIDING DOOR COMBINABLE WITH FIXED PANEL.

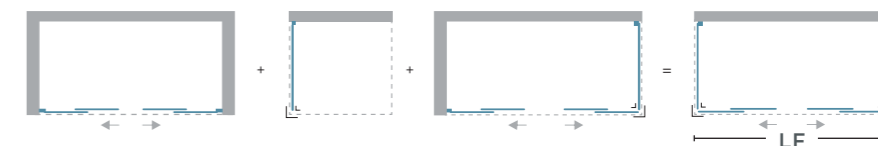

## ESSENCE N2FS (abbinamento a due ante fisse)

CABINA

CODICE	ESTENSIBILITÀ		INGR.	COLORE	TRASP.	CINCILLÀ	ACIDATO	COLLI
	STANDARD	ABBINATO A F1						
BEN20	115,5 - 120	120	46	Bianco	€ 379	€ 421	€ 485	2
				Ossidato lucido	€ 414	€ 456	€ 520	
BEN21	125,5 - 130	130	51	Bianco	€ 387	€ 432	€ 487	2
				Ossidato lucido	€ 423	€ 467	€ 522	
BEN22	135,5 - 140	140	56	Bianco	€ 401	€ 450	€ 515	2
				Ossidato lucido	€ 437	€ 486	€ 551	
BEN23	145,5 - 150	150	61	Bianco	€ 412	€ 465	€ 530	2
				Ossidato lucido	€ 448	€ 500	€ 567	
BEN24	155,5 - 160	160	66	Bianco	€ 424	€ 479	€ 546	2
				Ossidato lucido	€ 460	€ 515	€ 582	
BEN25	165,5 - 170	170	71	Bianco	€ 437	€ 497	€ 574	2
				Ossidato lucido	€ 474	€ 534	€ 610	

### NOTA

LF\* - Nell'abbinamento a due Ante Fisse la lunghezza frontale della cabina resta fissa.

**OPTIONAL** **AQVAclean** + € 90 per trattamento aqvaclean su N2FS. (for aqvaclean treatment on N2FS.)

## ESSENCE F1

ANTA FISSA

CODICE	ESTENSIBILITÀ STANDARD	INGR.	COLORE	TRASP.	CINCILLÀ	ACIDATO	COLLI	
								BEN20
BEN21	125,5 - 130	130	51	Ossidato lucido	€ 195	€ 217	€ 240	1
BEF11	72 - 74,5	-	-	Bianco	€ 185	€ 209	€ 231	1
				Ossidato lucido	€ 201	€ 225	€ 247	
BEF12	77 - 79,5	-	-	Bianco	€ 193	€ 219	€ 246	1
				Ossidato lucido	€ 209	€ 235	€ 262	
BEF13	87 - 89,5	-	-	Bianco	€ 204	€ 234	€ 261	1
				Ossidato lucido	€ 221	€ 250	€ 278	

### NOTA

Per una composizione corretta del box a due ante fisse è necessario calcolare X2 F1 i prezzi del listino

**OPTIONAL** **AQVAclean** + € 90 per trattamento aqvaclean su F1. (for aqvaclean treatment on F1.)

### DIMENSIONE PROFILI A PARETE. DIMENSIONS OF PROFILES AT THE WALL.

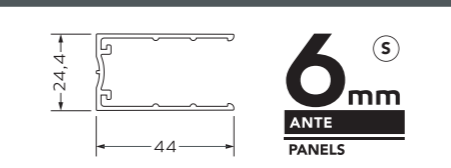

### CONDIZIONI FUORI MISURA CONDITIONS FOR CUSTOM SIZE

N2FS	F1
H max 220 cm	H max 220 cm
L min 80 cm	L min 20 cm
L max 200 cm	L max 135 cm
Maggiorazione del 30% per fuorimisura 30% surcharge for non standard	

## MODALITÀ D'ORDINE PER CODICE PRODOTTO

### ORDER PROCEDURE FOR PRODUCT CODE

Il codice finale che identifica inequivocabilmente un prodotto della linea ESSENCE è formato da più parti, ciascuna delle quali descrive una caratteristica o un'opzione.

La prima parte del codice è l'insieme delle lettere e numeri che identifica il modello, la serie e la misura: questo valore è riportato nella colonna CODICE in ciascuna tabella specifica per modello.

Ad esempio, BEA10 identifica il mod. ESSENCE con misure 67,5 - 70 cm della collezione URBAN. Tuttavia il codice non è ancora completo, perché dovrà essere specificato il verso di apertura, destro o sinistro.

Al codice identificativo del prodotto seguono due lettere DX o SX rispettivamente ad indicare il verso di apertura destro o sinistro.

Questa ulteriore specifica è volta a descrivere il tipo di esecuzione (ingresso collocato a destra o a sinistra) o il verso di apertura (verso destra o verso sinistra).

Nell'esempio precedente il codice caratteristico della versione destra è il seguente: BEA10DX mod. ESSENCE con misure 67,5 - 70 cm e apertura destra (DX).

Al codice completo del modello segue il tipo di pannello desiderato. Il codice dei pannelli disponibili è indicato nella sezione PANNELLI E COLORI DISPONIBILI.

Così, se la cabina doccia dell'esempio citato è desiderata con cristallo trasparente (cod. 104), il codice d'ordine sarà il seguente:

BEA10 DX 104: mod. ESSENCE con misure 67,5 - 70 cm, apertura verso destra (DX) e cristallo trasparente 6 mm (104).

Il completamento del codice avviene indicando il colore dei profili: BEA10 DX 104 215.

The final code that uniquely identifies a product of line ESSENCE consists of several parts, each of which describes a feature or option.

The first part of the code is made of letters and numbers that identifies the model, the number and size: this value is reported in the column CODE in each specific chart for model.

For example, BEA10 identifies the mod. ESSENCE with measures 67,5 - 70 cm of URBAN collection. However, the code is not yet complete, because will need to specify the opening direction, right or left.

The product identification code follows two letters right (DX) or left (SX), respectively, indicating the opening direction right or left. This further specification means to describe the type of execution (the entrance located to the right or left) or the opening direction (to the right or to the left).

In the above example the code characteristic of the right version is: BEA10DX mod. ESSENCE with measures 67,5 - 70 cm with right opening (DX).

The full code of the model follows the panel type desired. The codes of the available glasses is in section PANELS AND COLORS.

So, if the shower enclosure of the example mentioned is desired with transparent glass (code 104), the order code will be as follows: BEA10 DX 104: mod. ESSENCE with measures 67,5 - 70 cm, opening to the right (DX) and 6 mm transparent glass (104).

The completion of the code becomes indicating the finish of the profile: BEA10 DX 104 215.

MODELLO	APERTURA O VERSIONE	TIPO PANNELLO	COLORE PROFILI
<b>BEA10</b>	<b>DX</b>	<b>104</b>	<b>215</b>

MODEL	OPENING DIRECTION	PANEL TYPE	COLOUR
<b>BEA10</b>	<b>DX</b>	<b>104</b>	<b>215</b>



## MODALITÀ D'ORDINE FORMATS OF ORDER

RIVENDITORE.  
RESELLER.

---

---

---

---

---

---

---

---

RIFERIMENTO.  
REFERMENT.

---

---

---

---

---

---

---

---

DATA.  
DATE.

---

---

---

---

---

---

---

---

PREVENTIVO.  
QUOTATION.

ORDINE.  
ORDER.

RICHIESTA  
DI FATTIBILITÀ.  
REQUEST FOR  
FEASIBILITY.

**ATTENZIONE.**  
Le misure devono  
essere rilevate  
a piattodoccia  
e rivestimenti  
installati.

**ATTENTION.**  
Dimensions must  
be detected after  
the installation  
of shower tray  
and tiles.

PORTE.  
DOOR ENCLOSURES.

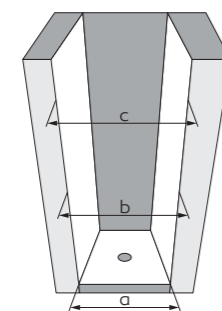
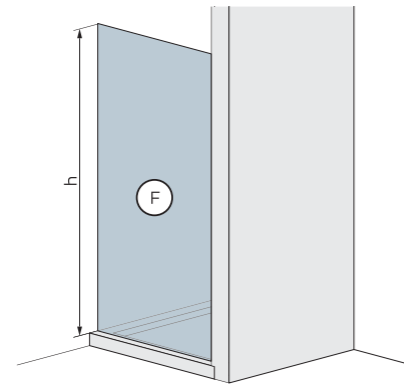

a ..... cm.  
b ..... cm.  
c ..... cm.  
h ..... cm.

**F** SOLUZIONE DESIDERATA.  
DESIRED SHOWER ENCLOSURE

PANNELLO. PANELS.

- 104** Cristallo temperato 6 mm TRASPARENTE.  
Tempered 6 mm glass TRANSPARENT.
- 103** Cristallo temperato 6 mm TRASPARENTE.  
Tempered 6 mm glass TRANSPARENT.  
(con AQVAClean/with AQVAClean)
- 401** Cristallo temperato 6 mm CINCILLÀ.  
Tempered 6 mm glass CHINCHILLA.
- 400** Cristallo temperato 6 mm CINCILLÀ.  
Tempered 6 mm glass CHINCHILLA.  
(con AQVAClean/with AQVAClean)
- 501** Cristallo temperato 6 mm ACIDATO.  
Tempered 6 mm glass FROSTED.
- 500** Cristallo temperato 6 mm ACIDATO.  
Tempered 6 mm glass FROSTED.  
(con AQVAClean/with AQVAClean)

COLORE. COLOUR.

- 215** Bianco RAL 9010.
- 348** Ossidato LUCIDO

ANGOLI.  
CORNER ENCLOSURES.

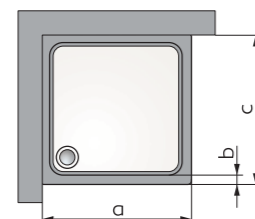
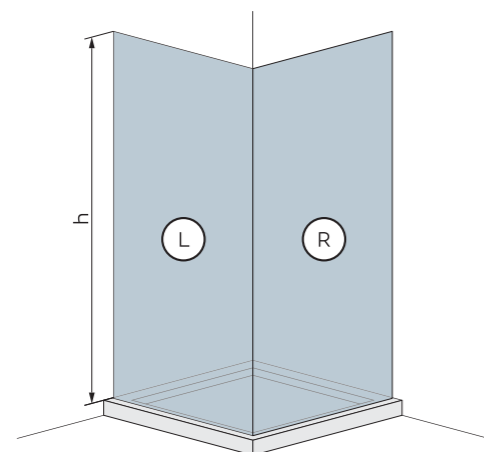

a ..... cm.  
b ..... cm.  
c ..... cm.  
h ..... cm.

**L** SOLUZIONE DESIDERATA PER IL LATO L.  
DESIRED SHOWER ENCLOSURE FOR L SIDE.

**R** SOLUZIONE DESIDERATA PER IL LATO R.  
DESIRED SHOWER ENCLOSURE FOR R SIDE.

PANNELLO. PANELS.

- 104** Cristallo temperato 6 mm TRASPARENTE.  
Tempered 6 mm glass TRANSPARENT.
- 103** Cristallo temperato 6 mm TRASPARENTE.  
Tempered 6 mm glass TRANSPARENT.  
(con AQVAClean/with AQVAClean)
- 401** Cristallo temperato 6 mm CINCILLÀ.  
Tempered 6 mm glass CHINCHILLA.
- 400** Cristallo temperato 6 mm CINCILLÀ.  
Tempered 6 mm glass CHINCHILLA.  
(con AQVAClean/with AQVAClean)
- 501** Cristallo temperato 6 mm ACIDATO.  
Tempered 6 mm glass FROSTED.
- 500** Cristallo temperato 6 mm ACIDATO.  
Tempered 6 mm glass FROSTED.  
(con AQVAClean/with AQVAClean)

COLORE. COLOUR.

- 215** Bianco RAL 9010.
- 348** Ossidato LUCIDO

## MODALITÀ D'ORDINE FORMATS OF ORDER

RIVENDITORE.  
RESELLER.

---

---

---

---

---

---

---

---

RIFERIMENTO.  
REFERMENT.

---

---

---

---

---

---

---

---

DATA.  
DATE.

---

---

---

---

---

---

---

---

PREVENTIVO.  
QUOTATION.

ORDINE.  
ORDER.

RICHIESTA  
DI FATTIBILITÀ.  
REQUEST FOR  
FEASIBILITY.

**ATTENZIONE.**  
Le misure devono  
essere rilevate  
a piattodoccia  
e rivestimenti  
installati.

**ATTENTION.**  
Dimensions must  
be detected after  
the installation  
of shower tray  
and tiles.

TRE LATI.  
THREE SIDES ENCLOSURES.

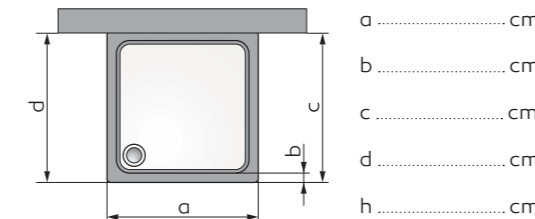
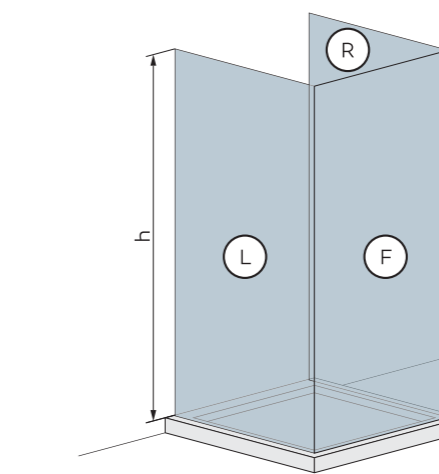

a ..... cm.  
b ..... cm.  
c ..... cm.  
d ..... cm.  
h ..... cm.

**L** SOLUZIONE DESIDERATA PER IL LATO L.  
DESIRED SHOWER ENCLOSURE FOR L SIDE.

**F** SOLUZIONE DESIDERATA PER IL LATO F.  
DESIRED SHOWER ENCLOSURE FOR F SIDE.

**R** SOLUZIONE DESIDERATA PER IL LATO R.  
DESIRED SHOWER ENCLOSURE FOR R SIDE.

PANNELLO. PANELS.

- 104** Cristallo temperato 6 mm TRASPARENTE.  
Tempered 6 mm glass TRANSPARENT.
- 103** Cristallo temperato 6 mm TRASPARENTE.  
Tempered 6 mm glass TRANSPARENT.  
(con AQVAClean/with AQVAClean)
- 401** Cristallo temperato 6 mm CINCILLÀ.  
Tempered 6 mm glass CHINCHILLA.
- 400** Cristallo temperato 6 mm CINCILLÀ.  
Tempered 6 mm glass CHINCHILLA.  
(con AQVAClean/with AQVAClean)
- 501** Cristallo temperato 6 mm ACIDATO.  
Tempered 6 mm glass FROSTED.
- 500** Cristallo temperato 6 mm ACIDATO.  
Tempered 6 mm glass FROSTED.  
(con AQVAClean/with AQVAClean)

COLORE. COLOUR.

- 215** Bianco RAL 9010.
- 348** Ossidato LUCIDO

ANGOLI (CASO 1).  
CORNER ENCLOSURES (CASE 1).

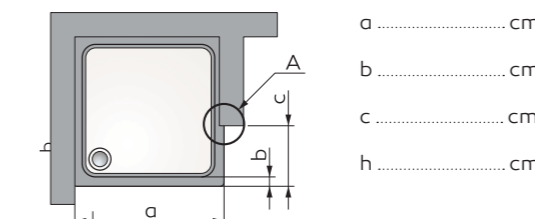
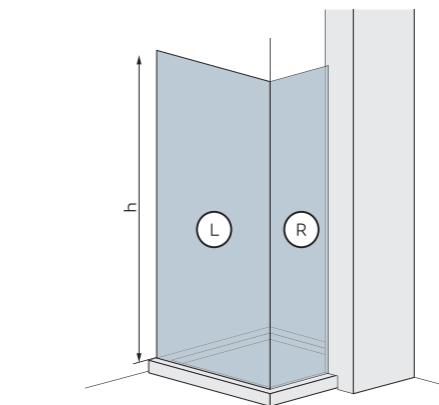

a ..... cm.  
b ..... cm.  
c ..... cm.  
h ..... cm.

**L** SOLUZIONE DESIDERATA PER IL LATO L.  
DESIRED SHOWER ENCLOSURE FOR L SIDE.

**R** SOLUZIONE DESIDERATA PER IL LATO R.  
DESIRED SHOWER ENCLOSURE FOR R SIDE.

PANNELLO. PANELS.

- 104** Cristallo temperato 6 mm TRASPARENTE.  
Tempered 6 mm glass TRANSPARENT.
- 103** Cristallo temperato 6 mm TRASPARENTE.  
Tempered 6 mm glass TRANSPARENT.  
(con AQVAClean/with AQVAClean)
- 401** Cristallo temperato 6 mm CINCILLÀ.  
Tempered 6 mm glass CHINCHILLA.
- 400** Cristallo temperato 6 mm CINCILLÀ.  
Tempered 6 mm glass CHINCHILLA.  
(con AQVAClean/with AQVAClean)
- 501** Cristallo temperato 6 mm ACIDATO.  
Tempered 6 mm glass FROSTED.
- 500** Cristallo temperato 6 mm ACIDATO.  
Tempered 6 mm glass FROSTED.  
(con AQVAClean/with AQVAClean)





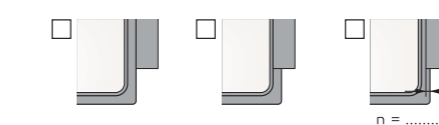





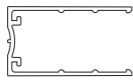
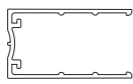
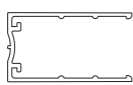

COLORE. COLOUR.

- 215** Bianco RAL 9010.
- 348** Ossidato LUCIDO



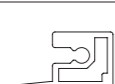







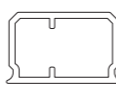
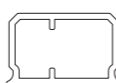
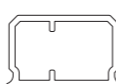
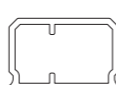

n = .....cm









## ACCESSORI ACCESSORIES

PROFILI. PROFILE.	IMMAGINE. IMAGE.	CODICE. CODE.	DESCRIZIONE. DESCRIPTION.	PREZZO. PRICE.
		RSL10022152000.1	Montante Laterale ESSENCE con fori H= 200 cm - Bianco RAL 9010 <i>Lateral pillar profile for ESSENCE with holes H= 200 cm - White RAL 9010</i>	€ 18,90
		RSL10023482000.1	Montante Laterale ESSENCE con fori H= 200 cm - Ossidato LUCIDO <i>Lateral pillar profile for ESSENCE with holes H= 200 cm - Polished Oxidized</i>	€ 22,50
		RSL10022152200.1	Montante Laterale ESSENCE con fori H= 220 cm - Bianco RAL 9010 <i>Lateral pillar profile for ESSENCE with holes H= 220 cm - White RAL 9010</i>	€ 20,40
		RSL10023482200.1	Montante Laterale ESSENCE con fori H= 220 cm - Ossidato LUCIDO <i>Lateral pillar profile for ESSENCE with holes H= 220 cm - Polished Oxidized</i>	€ 24,40
		RSL10002151610	Profilo di scorrimento per ESSENCE L= 100 cm - Bianco RAL 9010 <i>Rail profile for ESSENCE L= 100 cm - White RAL 9010</i>	€ 15,20
		RSL10003481610	Profilo di scorrimento per ESSENCE L= 100 cm - Ossidato LUCIDO <i>Rail profile for ESSENCE L= 100 cm - Polished Oxidized</i>	€ 16,10
		RSL10002152000	Profilo di scorrimento per ESSENCE L= 200 cm - Bianco RAL 9010 <i>Rail profile for ESSENCE L= 200 cm - White RAL 9010</i>	€ 26
		RSL10003482000	Profilo di scorrimento per ESSENCE L= 200 cm - Ossidato LUCIDO <i>Rail profile for ESSENCE L= 200 cm - Polished Oxidized</i>	€ 27,9 0
		RSL10012151610	Profilo inferiore per ESSENCE L= 100 cm - Bianco RAL 9010 <i>Lower profile for ESSENCE L= 100 cm - White RAL 9010</i>	€ 8,20
		RSL10013481610	Profilo inferiore per ESSENCE L= 100 cm - Ossidato LUCIDO <i>Lower profile for ESSENCE L= 100 cm - Polished Oxidized</i>	€ 10,50
		RSL10012152000	Profilo inferiore per ESSENCE L= 200 cm - Bianco RAL 9010 <i>Lower profile for ESSENCE L= 200 cm - White RAL 9010</i>	€ 12
		RSL10013482000	Profilo inferiore per ESSENCE L= 200 cm - Ossidato LUCIDO <i>Lower profile for ESSENCE L= 200 cm - Polished Oxidized</i>	€ 16,50
		RSL10032151945	Profilo di chiusura lato vetro per ESSENCE H= 194,5 cm - Bianco RAL 9010 <i>Closure profile glass side for ESSENCE H= 194,5 cm - White RAL 9010</i>	€ 9,80
		RSL10033481945	Profilo di chiusura lato vetro per ESSENCE H= 194,5 cm - Ossidato LUCIDO <i>Closure profile glass side for ESSENCE H= 194,5 cm - Polished Oxidized</i>	€ 14,60

## ACCESSORI ACCESSORIES

PROFILI. PROFILE.	IMMAGINE. IMAGE.	CODICE. CODE.	DESCRIZIONE. DESCRIPTION.	PREZZO. PRICE.
		RSL10032152145	Profilo di chiusura lato vetro per ESSENCE H= 214,5 cm - Bianco RAL 9010 <i>Closure profile glass side for ESSENCE H= 214,5 cm - White RAL 9010</i>	€ 10,30
		RSL10033482145	Profilo di chiusura lato vetro per ESSENCE H= 214,5 cm - Ossidato LUCIDO <i>Closure profile glass side for ESSENCE H= 214,5 cm - Polished Oxidized</i>	€ 15,70
		RSL10042151945	Profilo di chiusura montante per ESSENCE H= 194,5 cm - Bianco RAL 9010 <i>Closure profile for ESSENCE H= 194,5 cm - White RAL 9010</i>	€ 11,40
		RSL10043481945	Profilo di chiusura montante per ESSENCE H= 194,5 cm - Ossidato LUCIDO <i>Closure profile for ESSENCE H= 194,5 cm - Polished Oxidized</i>	€ 15,90
		RSL10042152145	Profilo di chiusura montante per ESSENCE H= 214,5 cm - Bianco RAL 9010 <i>Closure profile for ESSENCE H= 214,5 cm - White RAL 9010</i>	€ 12,20
		RSL10043482145	Profilo di chiusura montante per ESSENCE H= 214,5 cm - Ossidato LUCIDO <i>Closure profile for ESSENCE H= 214,5 cm - Polished Oxidized</i>	€ 17,10
		RSL10052151964	Profilo angolare per ESSENCE H= 196,4 cm - Bianco RAL 9010 <i>Angular profile for ESSENCE H= 196,4 cm - White RAL 9010</i>	€ 10,60
		RSL10053481964	Profilo angolare montante per ESSENCE H= 196,4 cm - Ossidato LUCIDO <i>Angular profile for ESSENCE H= 196,4 cm - Polished Oxidized</i>	€ 15,30
		RSL10052152164	Profilo angolare per ESSENCE H= 216,4 cm - Bianco RAL 9010 <i>Lower profile for ESSENCE H= 216,4 cm - Glossy White 501</i>	€ 11,20
		RSL10053482164	Profilo angolare montante per ESSENCE H= 216,4 cm - Ossidato LUCIDO <i>Lower profile for ESSENCE H= 216,4 cm - Polished Oxidized</i>	€ 16,4 0
		RSL10061011000	Profilo guarnizione inferiore L= 100 cm - Trasparente <i>Lower gasket profile L= 100 cm - Transparent</i>	€ 4,80
		RFL51851011000	Profilo pinna per guida inferiore inferiore L= 100 cm - Trasparente <i>Lower guide pin profile L=100 cm - Transparent</i>	€ 7
		RBA61331012200	Profilo pinna 90° micro con aletta 8mm H= 220cm - Trasparente <i>90° fin Pvc profile with fin length: 8 mm (H= 220 cm) - Transparent</i>	€ 5,40
		RSL10033481945	Profilo coestruso di attacco a cristallo 6mm H= 2200 cm - Trasparente <i>Coextrusion profile for 6mm glass attachment H= 2200 cm - Transparent</i>	€ 5

## ACCESSORI ACCESSORIES

PROFILI. PROFILE.	IMMAGINE. IMAGE.	CODICE. CODE.	DESCRIZIONE. DESCRIPTION.	PREZZO. PRICE.
		RBA10411011990	Profilo palloncino micro H= 199 cm - Trasparente <i>Micro vertical seal profile (H= 199 cm)</i> - Transparent	€ 12,10
		RBA10411012200	Profilo palloncino micro H= 220 cm - Trasparente <i>Micro vertical seal profile (H= 220 cm)</i> - Transparent	€ 12,90
		REV10381011990	Profilo magnetico 45° micro H= 199 cm - Trasparente <i>45° micro magnetic pvc profile (H= 199 cm)</i> - Transparent	€ 13,50
		REV10381012200	Profilo magnetico 45° micro H= 220 cm - Trasparente <i>45° micro magnetic pvc profile (H= 220 cm)</i> - Transparent	€ 14,50
		RBA10371011990	Profilo magnetico 180° micro H= 199 cm - Trasparente <i>180° micro magnetic pvc profile (H= 199 cm)</i> - Transparent	€ 13
		RBA10371012200	Profilo magnetico 180° micro H= 220 cm - Trasparente <i>180° micro magnetic pvc profile (H= 220 cm)</i> - Transparent	€ 14
		RBA9211012200	Profilo di chiusura 3 mm H= 220 cm - Trasparente <i>Closure profile 3 mm H= 220 cm</i> - Transparent	€ 5
		RPG60091012200	Guarnizione fermavetro cava 2 mm H= 220 cm - Trasparente <i>Glass stop seal 2mm H=220 cm</i> - Transparent	€ 1,30

NOTE.  
NOTE.

NOTE.  
NOTE.



## ACCESSORI ACCESSORIES

ACCESSORI. ACCESSORIES.	CODICE. CODE.	DESCRIZIONE. DESCRIPTION.	PREZZO. PRICE.
	RURK6126001	Kit maniglia "ETRO" (interasse fori: 300 mm) - Bianco RAL 9010 <i>Complete "ETRO" handle in kit (centre to centre distance: 300 mm)</i> - White RAL 9010	€ 8,40
	RURK6126052	Kit maniglia "ETRO" (interasse fori: 300 mm) - Cromata <i>Complete "ETRO" handle in kit (centre to centre distance: 300 mm)</i> - Chromium-plated	€ 7,40
	RURK2009253	Kit squadretta di FISSAGGIO a montante per ESSENCE <i>Kit fixing bracket for ESSENCE</i>	€ 9,90
	RURK2005239	Kit accessori preassemblati su profili ESSENCE <i>Kit Pre-assembled accessories on ESSENCE profiles</i>	€ 6,10
	RSLK2010001	Kit sistema di scorrimento per un'anta scorrevole ESSENCE - Bianco RAL 9010 <i>Kit sliding system for one ESSENCE sliding door</i> - White RAL 9010	€ 11,70
	RSLK2010052	Kit sistema di scorrimento per un'anta scorrevole ESSENCE - Cromato <i>Kit sliding system for one ESSENCE sliding door</i> - Chromium-plated	€ 11,70
	RURK2001001	KIT Accessori per mod. ESSENCE A1FS - Bianco RAL 9010 <i>Accessory kit for ESSENCE A1FS model</i> - White RAL 9010	€ 14,10
	RURK2001052	KIT Accessori per mod. ESSENCE A1FS - Cromato <i>Accessory kit for ESSENCE A1FS model</i> - Chromium-plated	€ 20,80
	RURK2002001	KIT Accessori per mod. ESSENCE N1FS - Bianco RAL 9010 <i>Accessory kit for ESSENCE N1FS model</i> - White RAL 9010	€ 11,50
	RURK2002052	KIT Accessori per mod. ESSENCE N1FS - Cromato <i>Accessory kit for ESSENCE N1FS model</i> - Chromium-plated	€ 15
	RURK2003001	KIT Accessori per mod. ESSENCE N2FS - Bianco RAL 9010 <i>Accessory kit for ESSENCE N2FS model</i> - White RAL 9010	€ 12,70
	RURK2003052	KIT Accessori per mod. ESSENCE N2FS - Cromato <i>Accessory kit for ESSENCE N2FS model</i> - Chromium-plated	€ 17,10
	RURK2004001	KIT Accessori per mod. ESSENCE F1 - Bianco RAL 9010 <i>Accessory kit for ESSENCE F1 model</i> - White RAL 9010	€ 5,60
	RURK2004052	KIT Accessori per mod. ESSENCE F1 - Cromato <i>Accessory kit for ESSENCE F1 model</i> - Chromium-plated	€ 9

## ACCESSORI ACCESSORIES

ACCESSORI. ACCESSORIES.	CODICE. CODE.	DESCRIZIONE. DESCRIPTION.	PREZZO. PRICE.
	RSL10072152000	Kit COVER XL per ESSENCE L= 200 cm - Bianco RAL 9010 <i>Kit COVER XL for ESSENCE L= 200 cm</i> - White RAL 9010	€ 28
	RSL10073482000	Kit COVER XL per ESSENCE L= 200 cm - Ossidato Lucido <i>Kit COVER XL for ESSENCE L= 200 cm</i> - Polished Oxidized	€ 33
	RSL10072154000	Kit COVER XL per ESSENCE 2 x L= 200 cm - Bianco RAL 9010 <i>Kit COVER XL for ESSENCE 2 x L= 200 cm</i> - White RAL 9010	€ 37
	RSL10073484000	Kit COVER XL per ESSENCE 2 x L= 200 cm - Ossidato Lucido <i>Kit COVER XL for ESSENCE 2 x L= 200 cm</i> - Polished Oxidized	€ 48

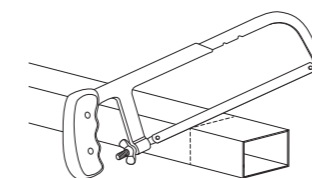

La lunghezza della Cover è riducibile a seconda della dimensione dei box doccia.  
Per i dettagli di installazione si rinvia alla scheda di montaggio.

NOTE.  
NOTE.

# URBAN BASIC EVOLUTION

---

Gamma basic della collezione Urban, Evolution combina la forza e la resistenza del PVC all'eleganza del cristallo temperato 6mm. Garantita anche per la linea Evolution, l'adattabilità ai corner e alle nicchie.





# EVOLUTION

Più Sicuro  
Più Utile  
Più Forte

---

La funzionalità, il cuore di ogni ambiente domestico  
ma soprattutto del tuo bagno.

Se unita allo stile, il risultato è un arredo pensato per ogni  
necessità, che non rinuncia a qualità ed estetica.



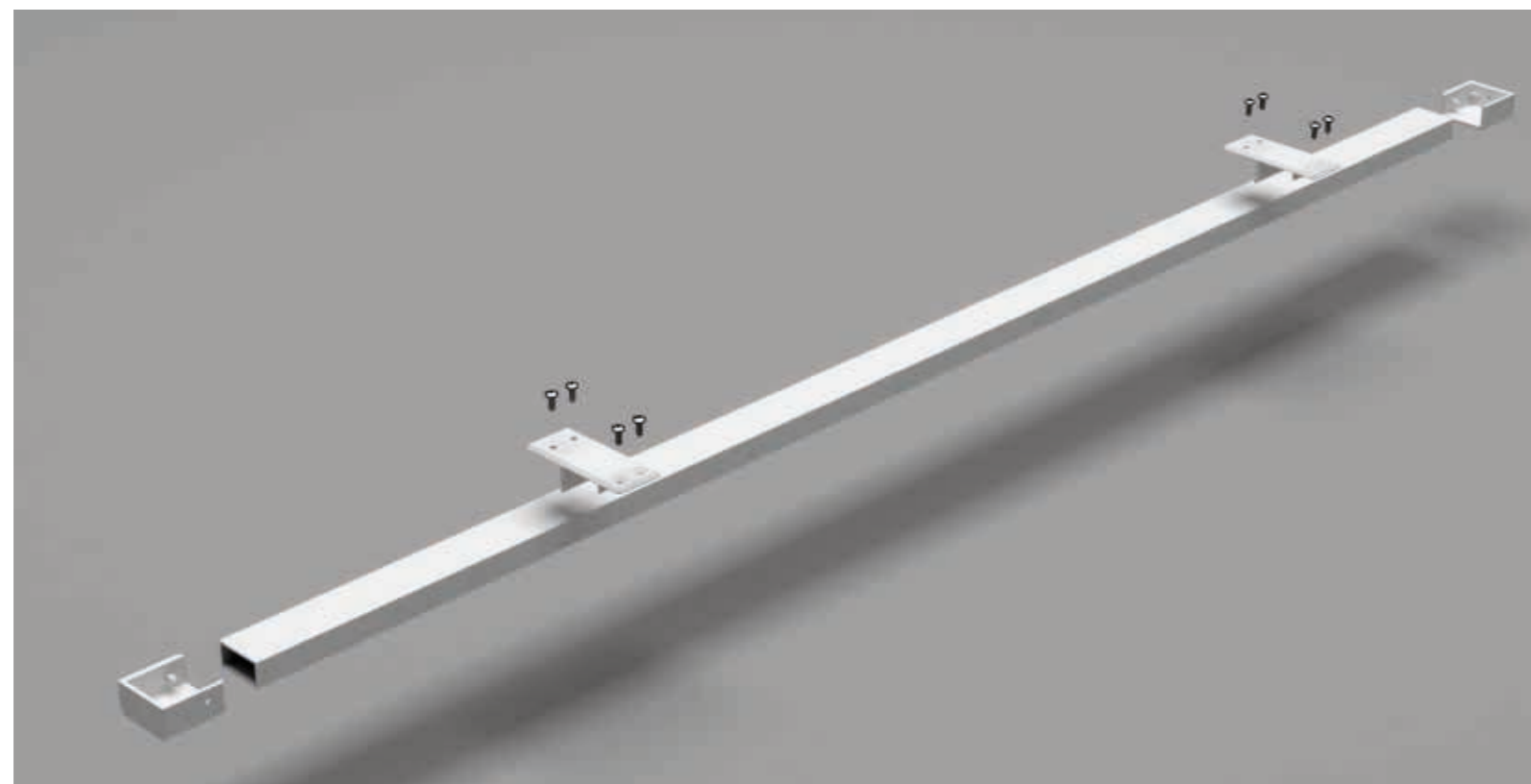

# EVOLUTION

è tutto questo  
e molto di più!

Sempre più performante nella struttura e nella sua utilità di arredo salvaspazio, con la nuova barra di sostegno riducibile, Evolution rivoluzionerà la nostra idea di box doccia.

• 1 KIT comprende

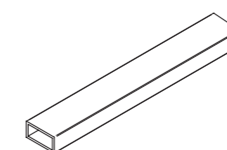

**BA6146**  
1 pz da 170 cm (kit)  
o 1 pz Misura box

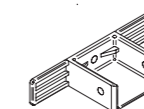

**BA6143**  
2 pz

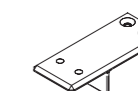

**BA6144**  
3 pz



**VT310335130**  
8 pz



**VT1203300200**  
8 pz



**VT11022390380**  
2 pz



**BA126000**  
2 pz



\*La barra di sostegno è un accessorio fornito di serie per i modelli Unix e Linux dal range di misure 120 - 110 cm in poi.

# URBAN BASIC

## EVOLUTION INDEX

PORTE.  
DOORS.

UNIX  
pag. 62

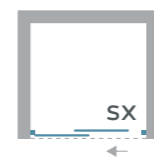
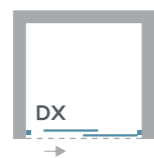

LINUX  
pag. 70

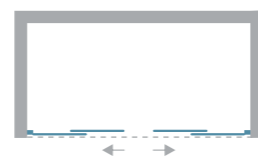

ANGOLI.  
CORNERS.

½FOX  
pag. 66

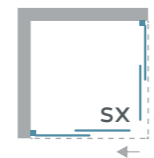
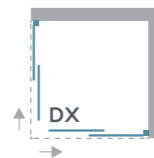

IN COMBINAZIONE  
CON ANTA FISSA.  
IN COMBINATION  
WITH FIXED PANEL

½FOX + FISSO X  
pag. 62

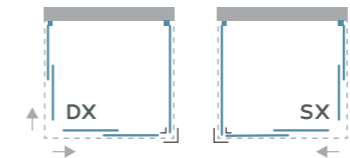

UNIX + FISSO X  
pag. 64

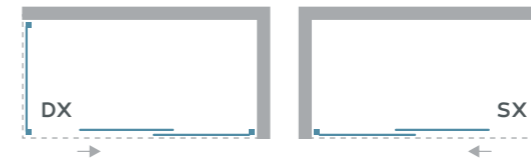

LINUX + FISSO X  
pag. 72

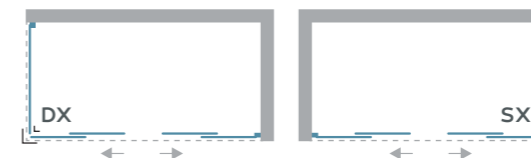

# URBAN BASIC

## EVOLUTION *INDEX*

---

COLORI.  
COLOURS.

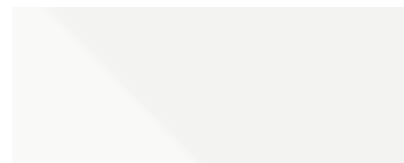

501 Bianco lucido LACCATO

PANNELLI.  
PANELS.



**104 Trasparente**  
Cristallo temperato 6 mm.  
Peso al m<sup>2</sup>: 15 kg

**Trasparent**  
6mm Tempered glass.  
Weight per m<sup>2</sup>: 15 kg



**401 Cincillà**  
Cristallo temperato 6 mm.  
Peso al m<sup>2</sup>: 15 kg

**Chinchilla**  
6mm Tempered glass.  
Weight per m<sup>2</sup>: 15 kg



# URBAN BASIC EVOLUTION

---

- **CRISTALLO 6 mm**  
*6mm TEMPERED GLASS*
- **SCORRIMENTO  
SU CUSCINETTI SILENZIATI  
IN ACCIAIO INOX**  
*SILENCED BEARING BALL WITH  
STAINLESS STEEL STRUCTURE*
- **RIDUCIBILE**  
*REDUCIBLE*
- **ANTIMUFFA**  
*ANTI-MOLD*
- **ANTIBATTERICO**  
*ANTI-BACTERIAL*
- **PROFILI ANTICALCARE**  
*ANTI-LIMESTONE*
- **REVERSIBILE**  
*REVERSIBLE*
- **FACILE MONTAGGIO**  
*EASY ASSEMBLING*
- **100% RICICLABILE**  
*100% RECYCLABLE*
- **GREEN PVC**

**10**  
ANNI  
YEARS  
**GARANZIA  
SU ACCESSORI  
E RICAMBI**  
WARRANTY  
ON ACCESSORIES  
AND SPARE PARTS





**EVOLUTION** Cicillà



# URBAN BASIC EVOLUTION *UNIX*

PORTA SCORREVOLE A DUE ANTE.  
TWO PANELS WITH ONE SLIDING DOOR.

- SI**  
SCORRIMENTO  
INOX
- E**  
ECO
- AB**  
ANTI  
BATTERICO
- D**  
RIDUCIBILE
- H**  
190,4 cm
- S**  
6 mm
- P**  
PVC
- R**  
REVERSIBILE
- M**  
MAGNETE
- AF**  
ANTA FISSA

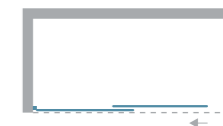

## EVOLUTION *UNIX*

CODICE	RIDUCIBILITÀ	INGR.	COLORE	TRASP.	CINCILLÀ	COLLI
BEV4100	100 - 90	41	Laccato	€ 168	€ 218	1
BEV4101	110 - 100	46	Laccato	€ 178	€ 231	1
BEV4102	120 - 110	51	Laccato	€ 210	€ 266	1
BEV4103	130 - 120	56	Laccato	€ 253	€ 322	2
BEV4104	140 - 130	61	Laccato	€ 265	€ 338	2
BEV4105	150 - 140	66	Laccato	€ 277	€ 353	2
<b>NEW</b> BEV4109	160 - 150	71	Laccato	€ 295	€ 370	2
<b>NEW</b> BEV4110	170 - 160	76	Laccato	€ 325	€ 400	2

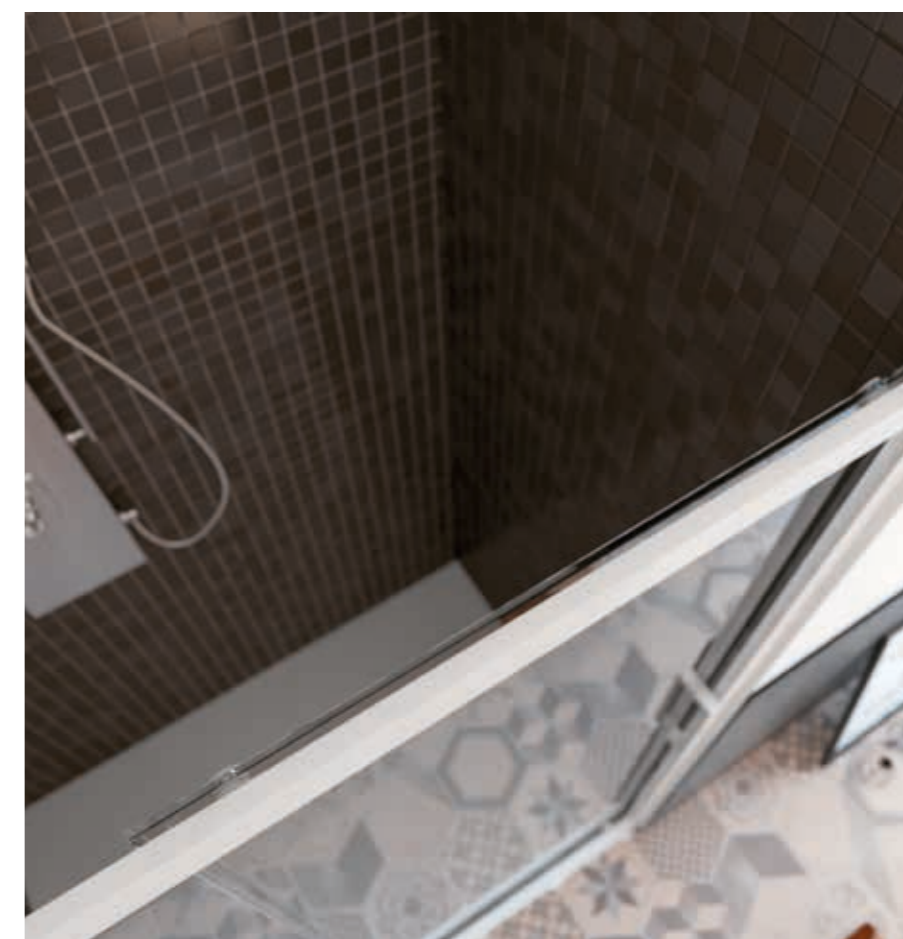

**DIMENSIONE PROFILI A PARETE.**  
DIMENSIONS OF PROFILES  
AT THE WALL.

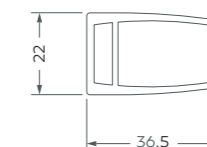

**6mm** <sup>S</sup>  
ANTE  
PANELS

# URBAN BASIC EVOLUTION *UNIX + FISSO X*

PORTA SCORREVOLE A DUE ANTE + ANTA FISSA.  
TWO PANELS WITH ONE SLIDING DOOR COMBINABLE WITH FIXED PANEL.

- (SI)  
SCORRIMENTO  
INOX
- (E)  
ECO
- (AB)  
ANTI  
BATTERICO
- (D)  
RIDUCIBILE
- (H)  
190,4 cm
- (S)  
6 mm
- (P)  
PVC
- (R)  
REVERSIBILE
- (M)  
MAGNETE
- (AF)  
ANTA FISSA



## EVOLUTION UNIX

CODICE	RIDUCIBILITÀ	INGR.	COLORE	TRASP.	CINCILLÀ	COLLI
BEV4100	100 - 90	41	Laccato	€ 168	€ 218	1
BEV4101	110 - 100	46	Laccato	€ 178	€ 231	1
BEV4102	120 - 110	51	Laccato	€ 210	€ 266	1
BEV4103	130 - 120	56	Laccato	€ 253	€ 322	2
BEV4104	140 - 130	61	Laccato	€ 265	€ 338	2
BEV4105	150 - 140	66	Laccato	€ 277	€ 353	2
<b>NEW</b> BEV4109	160 - 150	71	Laccato	€ 295	€ 370	2
<b>NEW</b> BEV4110	170 - 160	76	Laccato	€ 325	€ 400	2

## EVOLUTION FISSO X

CODICE	RIDUCIBILITÀ	INGR.	COLORE	TRASP.	CINCILLÀ	COLLI
BEV4300	67 - 69	-	Laccato	€ 130	€ 169	1
BEV4301	72 - 74	-	Laccato	€ 134	€ 174	1
BEV4302	77 - 79	-	Laccato	€ 140	€ 182	1
BEV4303	87 - 89	-	Laccato	€ 148	€ 192	1



DIMENSIONE PROFILI A PARETE.  
DIMENSIONS OF PROFILES  
AT THE WALL.

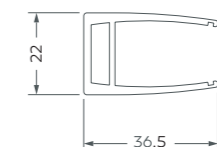

**6mm** (S)  
ANTE  
PANELS

# URBAN BASIC EVOLUTION <sup>1/2</sup> FOX

ANGOLO A QUATTRO ANTE.  
CORNER WITH TWO SLIDING DOOR.

- SI  
SCORRIMENTO  
INOX
- E  
ECO
- AB  
ANTI  
BATTERICO
- D  
RIDUCIBILE
- H  
190,4 cm
- S  
6 mm
- P  
PVC
- R  
REVERSIBILE
- M  
MAGNETE
- AF  
ANTA FISSA

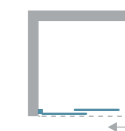

## EVOLUTION <sup>1/2</sup> FOX

CODICE	RIDUCIBILITÀ	INGR.	COLORE	TRASP.	CINCILLÀ	COLLI
BEV4000	70 - 65	38	Laccato	€ 120	€ 156	1
BEV4001	75 - 70	41	Laccato	€ 122	€ 159	1
BEV4002	80 - 75	45	Laccato	€ 128	€ 166	1
BEV4003	90 - 85	47	Laccato	€ 136	€ 177	1
BEV4004	100 - 95	59	Laccato	€ 170	€ 221	1
BEV4005	120 - 115	61	Laccato	€ 194	€ 252	1



DIMENSIONE PROFILI A PARETE.  
DIMENSIONS OF PROFILES  
AT THE WALL.

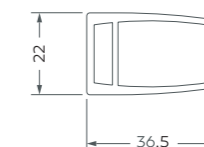

**6mm** <sup>S</sup>  
ANTE  
PANELS

# URBAN BASIC EVOLUTION $\frac{1}{2}$ FOX + FISSO X

ANGOLO A QUATTRO ANTE + ANTA FISSA.  
CORNER WITH TWO SLIDING DOOR COMBINABLE WITH FIXED PANEL.

- SI**  
SCORRIMENTO  
INOX
- E**  
ECO
- AB**  
ANTI  
BATTERICO
- D**  
RIDUCIBILE
- H**  
190,4 cm
- S**  
6 mm
- P**  
PVC
- R**  
REVERSIBILE
- M**  
MAGNETE
- AF**  
ANTA FISSA

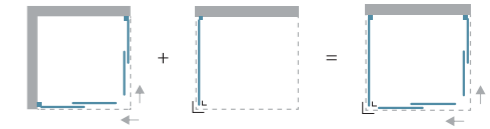

## EVOLUTION $\frac{1}{2}$ FOX

CODICE	RIDUCIBILITÀ	INGR.	COLORE	TRASP.	CINCILLÀ	COLLI
BEV4000	70 - 65	38	Laccato	€ 120	€ 156	1
BEV4001	75 - 70	41	Laccato	€ 122	€ 159	1
BEV4002	80 - 75	45	Laccato	€ 128	€ 166	1
BEV4003	90 - 85	47	Laccato	€ 136	€ 177	1
BEV4004	100 - 95	59	Laccato	€ 170	€ 221	1
BEV4005	120 - 115	61	Laccato	€ 194	€ 252	1

## EVOLUTION FISSO X

CODICE	RIDUCIBILITÀ	INGR.	COLORE	TRASP.	CINCILLÀ	COLLI
BEV4300	67 - 69	-	Laccato	€ 130	€ 169	1
BEV4301	72 - 74	-	Laccato	€ 134	€ 174	1
BEV4302	77 - 79	-	Laccato	€ 140	€ 182	1
BEV4303	87 - 89	-	Laccato	€ 148	€ 192	1



DIMENSIONE PROFILI A PARETE.  
DIMENSIONS OF PROFILES  
AT THE WALL.

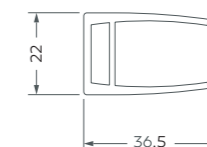

**6mm** <sup>S</sup>  
ANTE  
PANELS

# URBAN BASIC EVOLUTION *LINUX*

PORTA SCORREVOLE A QUATTRO ANTE.  
FOUR PANELS WITH TWO SLIDING DOOR.

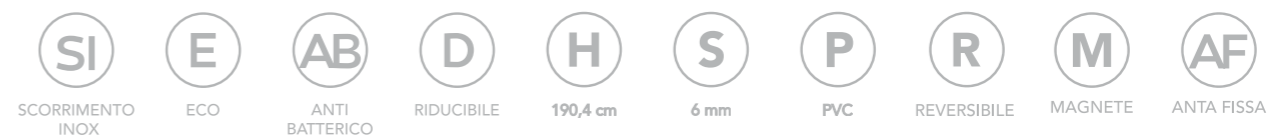

## EVOLUTION *LINUX*

CODICE	RIDUCIBILITÀ	INGR.	COLORE	TRASP.	CINCILLÀ	COLLI
BEV4200	120 - 110	46	Laccato	€ 286	€ 365	2
BEV4201	130 - 120	51	Laccato	€ 301	€ 384	2
BEV4202	140 - 130	56	Laccato	€ 313	€ 400	2
BEV4203	150 - 140	61	Laccato	€ 323	€ 412	2
BEV4204	160 - 150	66	Laccato	€ 335	€ 428	2
BEV4205	170 - 160	71	Laccato	€ 345	€ 441	2



**DIMENSIONE PROFILI A PARETE.**  
DIMENSIONS OF PROFILES  
AT THE WALL.

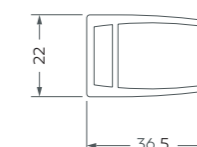

**6mm** <sup>S</sup>  
ANTE  
PANELS

# URBAN BASIC EVOLUTION *LINUX + FISSO X*

PORTA SCORREVOLE A QUATTRO ANTE + ANTA FISSA.  
FOUR PANELS WITH TWO SLIDING DOOR COMBINABLE WITH FIXED PANEL.

- (SI)  
SCORRIMENTO  
INOX
- (E)  
ECO
- (AB)  
ANTI  
BATTERICO
- (D)  
RIDUCIBILE
- (H)  
190,4 cm
- (S)  
6 mm
- (P)  
PVC
- (R)  
REVERSIBILE
- (M)  
MAGNETE
- (AF)  
ANTA FISSA

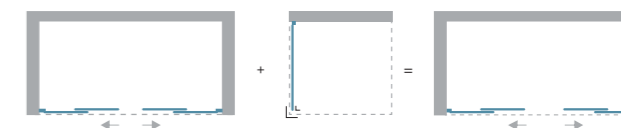

## EVOLUTION *LINUX*

CODICE	RIDUCIBILITÀ	INGR.	COLORE	TRASP.	CINCILLÀ	COLLI
BEV4200	120 - 110	46	Laccato	€ 286	€ 365	2
BEV4201	130 - 120	51	Laccato	€ 301	€ 384	2
BEV4202	140 - 130	56	Laccato	€ 313	€ 400	2
BEV4203	150 - 140	61	Laccato	€ 323	€ 412	2
BEV4204	160 - 150	66	Laccato	€ 335	€ 428	2
BEV4205	170 - 160	71	Laccato	€ 345	€ 441	2

## EVOLUTION *FISSO X*

CODICE	RIDUCIBILITÀ	INGR.	COLORE	TRASP.	CINCILLÀ	COLLI
BEV4300	67 - 69	-	Laccato	€ 130	€ 169	1
BEV4301	72 - 74	-	Laccato	€ 134	€ 174	1
BEV4302	77 - 79	-	Laccato	€ 140	€ 182	1
BEV4303	87 - 89	-	Laccato	€ 148	€ 192	1



DIMENSIONE PROFILI A PARETE.  
DIMENSIONS OF PROFILES  
AT THE WALL.

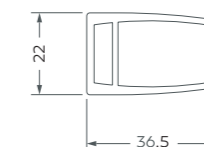

**6mm** (S)  
ANTE  
PANELS

## MODALITÀ D'ORDINE PER CODICE PRODOTTO

### ORDER PROCEDURE FOR PRODUCT CODE

Il codice d'ordine è composto da più parti, ciascuna delle quali identifica una specifica caratteristica.

La prima parte del codice rappresenta l'insieme delle lettere e numeri che identificano un modello, la serie e la misura: questo valore è riportato nella colonna CODICE di ciascuna tabella specifica per modello.

Ad esempio: BEV4000 identifica il mod. ½FOX con misure 70-65 cm della collezione EVOLUTION.

A questa parte di codice seguirà il tipo di pannello desiderato ed il codice colore della cabina doccia.

Le varianti dei pannelli disponibili sono riportati nella sezione PANNELLI E COLORI DISPONIBILI a pag. 9

Così, se la cabina doccia dell'esempio citato è desiderata con cristallo trasparente 6 mm, (cod. 104 da pag. 9), il codice d'ordine sarà il seguente:  
BEV4000 104: mod. ½FOX con misure 70-65 cm con cristallo trasparente 6 mm.

Il completamento del codice avviene indicando il colore della cabina doccia, scegliendolo tra le varianti cromatiche disponibili a pag. 9: BEV 104 501.

In tal caso il codice colore 501 si riferisce al colore Laccato.

#### ESEMPIO FINALE

##### BEV4000 104 501

Box doccia serie EVOLUTION mod. ½ FOX misure 70-65 cm con pannelli in cristallo temperato trasparente 6 mm e profili colore Laccato.

The order code is made of several parts, each of which identifies a specific characteristic.

The first part of the code is made of letters and numbers that identify the model, the collection and the size: this value is reported in the column CODE of each specific chart for each model.

For example: BEV4000 identifies the mod. ½ FOX with measures 70-65 cm EVOLUTION collection.

To this part of the code will follow the panel type and the desired color code of the shower enclosure.

The variant of the glasses are available in the column PANELS AND COLORS on page 9.

So, if the shower enclosure above mentioned is desired with clear glass (cod. 104 on page 9), the order code will be as follows:  
BEV4000 104: mod. ½ FOX with measure 70-65 cm with transparent glass 6 mm.

The completion of the code becomes with the selection of the shower enclosure colour, choosing between the color variants available on page 9: BEV 104 501.

In this case, the color code 501 refers to glossy white finish.

#### FINAL EXAMPLE

##### BEV4000 104 501

Shower enclosure EVOLUTION collection mod. ½ FOX measures 70-65 cm with tempered transparent glass 6 mm and PVC profile in glossy white color.

MODELLO

TIPO PANNELLO

COLORE PROFILI

**BEV4000 104 501**

MODEL

PANEL TYPE

COLOUR

**BEV4000 104 501**

## MODALITÀ D'ORDINE FORMATS OF ORDER

RIVENDITORE.  
RESELLER.

---

---

---

---

---

---

---

---

RIFERIMENTO.  
REFERMENT.

---

---

---

---

---

---

---

---

DATA.  
DATE.

---

---

---

---

---

---

---

---

PREVENTIVO.  
QUOTATION.

ORDINE.  
ORDER.

RICHIESTA  
DI FATTIBILITÀ.  
REQUEST FOR  
FEASIBILITY.

**ATTENZIONE.**  
Le misure devono  
essere rilevate  
a piattodoccia  
e rivestimenti  
installati.

**ATTENTION.**  
Dimensions must  
be detected after  
the installation  
of shower tray  
and tiles.

PORTE.  
DOOR ENCLOSURES.

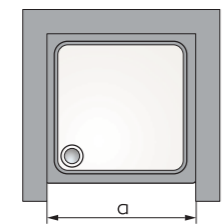
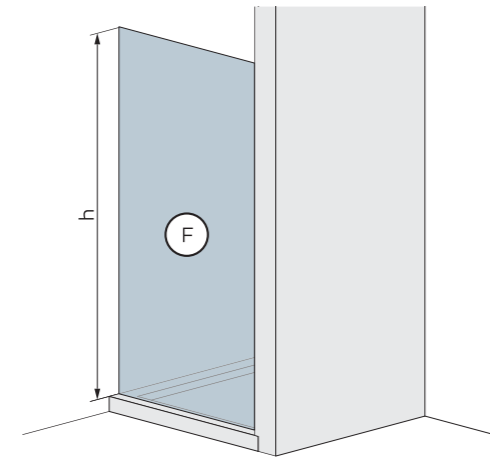

a ..... cm.  
h ..... cm.

**F** SOLUZIONE DESIDERATA.  
DESIRED SHOWER ENCLOSURE

PANNELLO. PANELS.

- 104** Cristallo temperato 6 mm TRASPARENTE.  
Tempered 6 mm glass TRANSPARENT.
- 401** Cristallo temperato 6 mm CINCILLÀ.  
Tempered 6 mm glass CHINCHILLA.

COLORE. COLOUR.

- 501** Bianco lucido LACCATO

ANGOLI.  
CORNER ENCLOSURES.

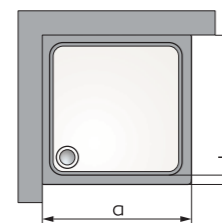
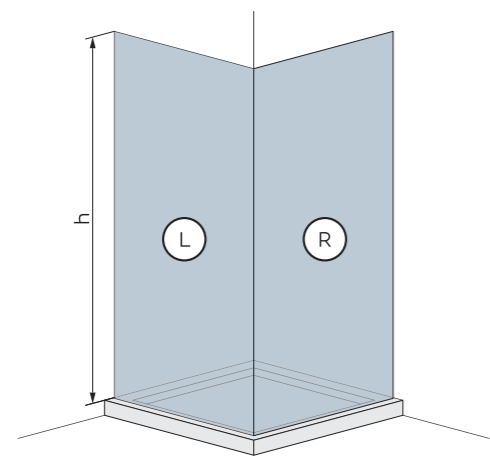

a ..... cm.  
b ..... cm.  
c ..... cm.  
h ..... cm.

**L** SOLUZIONE DESIDERATA PER IL LATO L.  
DESIRED SHOWER ENCLOSURE FOR L SIDE.

**R** SOLUZIONE DESIDERATA PER IL LATO R.  
DESIRED SHOWER ENCLOSURE FOR R SIDE.

PANNELLO. PANELS.

- 104** Cristallo temperato 6 mm TRASPARENTE.  
Tempered 6 mm glass TRANSPARENT.
- 401** Cristallo temperato 6 mm CINCILLÀ.  
Tempered 6 mm glass CHINCHILLA.

COLORE. COLOUR.

- 501** Bianco lucido LACCATO

## MODALITÀ D'ORDINE FORMATS OF ORDER

RIVENDITORE.  
RESELLER.

---

---

---

---

---

---

---

---

RIFERIMENTO.  
REFERMENT.

---

---

---

---

---

---

---

---

DATA.  
DATE.

---

---

---

---

---

---

---

---

PREVENTIVO.  
QUOTATION.

ORDINE.  
ORDER.

RICHIESTA  
DI FATTIBILITÀ.  
REQUEST FOR  
FEASIBILITY.

**ATTENZIONE.**  
Le misure devono  
essere rilevate  
a piattodoccia  
e rivestimenti  
installati.

**ATTENTION.**  
Dimensions must  
be detected after  
the installation  
of shower tray  
and tiles.

TRE LATI.  
THREE SIDES ENCLOSURES.

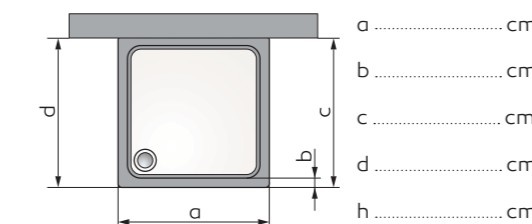
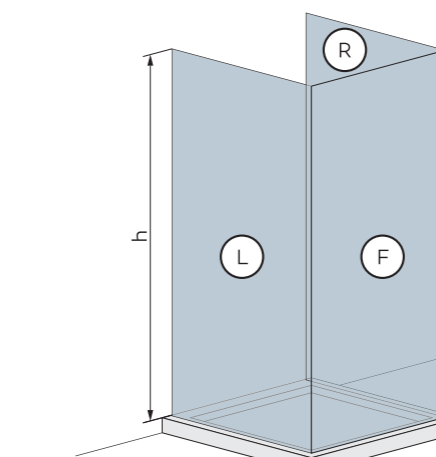

a ..... cm.  
b ..... cm.  
c ..... cm.  
d ..... cm.  
h ..... cm.

**L** SOLUZIONE DESIDERATA PER IL LATO L.  
DESIRED SHOWER ENCLOSURE FOR L SIDE.

**F** SOLUZIONE DESIDERATA PER IL LATO F.  
DESIRED SHOWER ENCLOSURE FOR F SIDE.

**R** SOLUZIONE DESIDERATA PER IL LATO R.  
DESIRED SHOWER ENCLOSURE FOR R SIDE.

PANNELLO. PANELS.

- 104** Cristallo temperato 6 mm TRASPARENTE.  
Tempered 6 mm glass TRANSPARENT.
- 401** Cristallo temperato 6 mm CINCILLÀ.  
Tempered 6 mm glass CHINCHILLA.

COLORE. COLOUR.

- 501** Bianco lucido LACCATO

ANGOLI (CASO 1).  
CORNER ENCLOSURES (CASE 1).

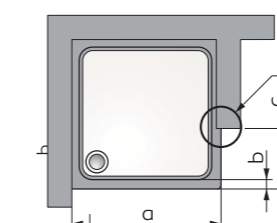
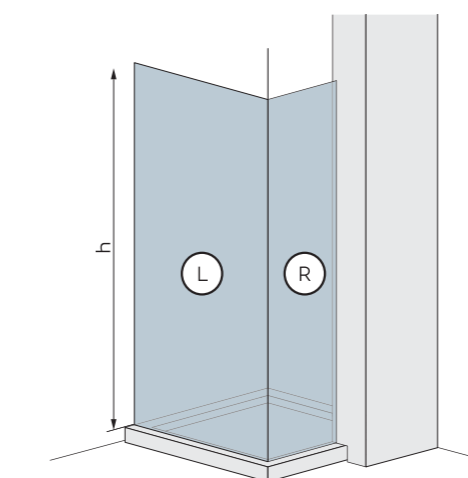

a ..... cm.  
b ..... cm.  
c ..... cm.  
d ..... cm.  
h ..... cm.

**L** SOLUZIONE DESIDERATA PER IL LATO L.  
DESIRED SHOWER ENCLOSURE FOR L SIDE.

**R** SOLUZIONE DESIDERATA PER IL LATO R.  
DESIRED SHOWER ENCLOSURE FOR R SIDE.

PANNELLO. PANELS.

- 104** Cristallo temperato 6 mm TRASPARENTE.  
Tempered 6 mm glass TRANSPARENT.
- 401** Cristallo temperato 6 mm CINCILLÀ.  
Tempered 6 mm glass CHINCHILLA.

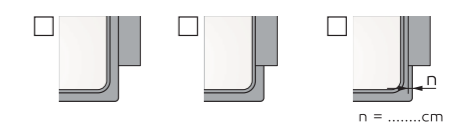

COLORE. COLOUR.

- 501** Bianco lucido LACCATO





## ACCESSORI ACCESSORIES

PROFILI. PROFILE.	IMMAGINE. IMAGE.	CODICE. CODE.	DESCRIZIONE. DESCRIPTION.	PREZZO. PRICE.
		RBA9105011904.1	Montante Laterale con fori H= 190,4 cm - Bianco Laccato 501 <i>Lateral pillar profile with holes H= 190,4 cm - Glossy White 501</i>	€ 9,60
		RBA9115010867	Coppia Profili di scorrimento per mod. FOX/UNIX L= 86,7 cm - Bianco Laccato 501 <i>Pair of rail profile for FOX/UNIX model L= 86,7 cm - Glossy White 501</i>	€ 11,20
		RBA9115011478.1	Coppia Profili di scorrimento per mod. FOX/UNIX L= 147,8 cm - Bianco Laccato 501 <i>Pair of rail profile for FOX/UNIX model L= 147,8 cm - Glossy White 501</i>	€ 16
		RBA9115011678.3	Coppia Profili di scorrimento per mod. LINUX L= 167,8 cm - Bianco Laccato 501 <i>Pair of rail profile for LINUX model L= 167,8 cm - Glossy White 501</i>	€ 17,60
		RBA9115010838.4	Coppia Profili di scorrimento per mod. FISSO X L= 83,8 cm - Bianco Laccato 501 <i>Pair of rail profile for FISSO X model L= 83,8 cm - Glossy White 501</i>	€ 11
		RBA9130011800	Profilo coprivite senza scasso H= 180 cm - Bianco Pastello 001 <i>Screw cover profile without break H= 180 cm - Pastel White 001</i>	€ 6
		RBA9130011800.1	Profilo coprivite con scasso H= 180 cm - Bianco Pastello 001 <i>Screw cover profile with break H= 180 cm - Pastel White 001</i>	€ 6
		RBA9145011904	Profilo angolare 190,4 cm - Bianco Laccato 501 <i>Angular profile H=190,4 cm - Glossy White 501</i>	€ 14,20
		RBA61331011880	Profilo pinna 90° micro con aletta 8mm H= 188 cm - Trasparente <i>90° fin Pvc profile with fin lenght: 8 mm (H= 188 cm) - Transparent</i>	€ 8,40
		RBA10371011880	Profilo magnetico 180° micro H= 188 cm - Trasparente <i>180° micro magnetic pvc profile (H= 188 cm) - Transparent</i>	€ 13
		RBA10381011880	Coppia di profili magnetici 45° micro H= 188 cm - Trasparente <i>Pair of 45° magnetic pvc profile (H= 188 cm) - Transparent</i>	€ 21,70
		RBA10411011880	Profilo palloncino micro H= 188 cm - Trasparente <i>Micro vertical seal profile (H= 188 cm) - Transparent</i>	€ 9,50
		RBA61350010800	Profilo di chiusura per scorrimento 6 mm L= 80 cm - Bianco Pastello 001 <i>Closing profile for rail profile 6 mm L= 80 cm - Pastel White 001</i>	€ 5,60
		RBA9220011800	Profilo guarnizione coprivite 4 mm H= 180 cm - Bianco Pastello 001 <i>Profile seal for Screw cover profile 4 mm H= 180 cm - Pastel White 001</i>	€ 5,60

ACCESSORI. ACCESSORIES.	CODICE. CODE.	DESCRIZIONE. DESCRIPTION.	PREZZO. PRICE.
	RBAK6126001	Kit maniglia "PIXEL" (interasse fori: 230 mm) - Bianco RAL 9010 <i>Complete "PIXEL" handle in kit (centre to centre distance: 230 mm) - White RAL 9010</i>	€ 7,40
	RBAK7013001	Kit sistema di scorrimento per un'anta scorrevole - Bianco RAL 9010 <i>Kit sliding system for one sliding door - White RAL 9010</i>	€ 15,60
	REVK2017001	KIT Accessori per 1/2 mod. FOX <i>Accessory kit for 1/2 FOX model</i>	€ 7,60
	REVK2018001	KIT Accessori per mod. UNIX <i>Accessory kit for UNIX model</i>	€ 9,20
	REVK2019001	KIT Accessori per mod. LINUX <i>Accessory kit for LINUX model</i>	€ 9,40
	BAK1416000	KIT Trattamento nanotecnologico "AQVAclean" <i>Nanotechnological "AQVAclean" treatment kit</i>	€ 50
	BAK6143001	KIT Barra di sostegno EVOLUTION <i>KIT support bar EVOLUTION</i>	€ 35
		La Barra di sostegno EVOLUTION è riducibile	
NOTE. NOTE.			

**FORTE** S.r.l.

C.da Parco Del Vecchio Bovio  
70022 Altamura (Ba) Italy

T +39 0803101237  
F +39 080 31 01 323

info@fortesrl.it  
**fortesrl.it**

follow on 



CONCEPT

**IN&OUT ADVERTISING**  
www.inoutadv.it

